

4 CH MPEG-2 Digital Video Recorder

780 V1.1

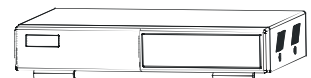

Please read these instructions thoroughly before operation and retain it for future reference.



WARNING

*All the safety and operating instructions should be read before operation.
The improper operation may cause permanent damage.*



- This adaptor is only for this machine.
Do not use it for other electronic products or it will damage other products.
- Please lift and place this equipment gently.
- Do not expose this equipment to direct sunlight.
- Do not use this equipment near water or in contact with water.
- Do not spill liquid of any kind on the equipment.
- Please power down the unit before unplugging.
- Do not block the ventilation holes at the top and bottom of the unit.
- Do not switch the Power On & Off within short period of time
(within 3 seconds).
- Installation should be made by qualified service personnel.



The lightning flash with arrowhead symbol, within an equilateral triangle, is intended to alert the user to the presence of uninsulated "dangerous voltage" within the product's enclosure that may be of sufficient magnitude to constitute a risk of electric shock to persons.

The exclamation point within an equilateral triangle is intended to alert the user to the presence of important operating and maintenance-(servicing) instructions in the literature accompanying the appliance.

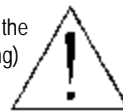



TABLE OF CONTENTS

1. What do you get ?

FEATURES _	1
PACKAGE CONTENT-	1

2. Before Operation

INSTALLATION GUIDE_	2
FRONT PANEL_	3
REAR PANEL_	5

3. Basic Operation

GETTING STARTED_	6
OPERATION_	7
<i>RECORDING</i> _	7
<i>PLAYBACK</i> _	8

4. Detailed Menu Setup

MAIN MENU_	10
MENU OPTIONS_	11
RECORD -	11
TIMER SETUP-	12
CAMERA -	13
DETECTION -	14
DISPLAY -	15
<i>PIP OPTION-</i>	17
<i>DWELL SETUP</i> -	18
USER -	19
SYSTEM -	20
<i>BUZZER SETUP-</i>	22
<i>REMOTE SETUP</i> -	23
<i>UPGRADE SETUP-</i>	24
EVENT-	25

5. *Advanced Operation*

OPERATION OPTIONS	26
2X ZOOM	26
VIDEO LOSS	26
SEARCH	27
USB BACKUP	30
KEY LOCK	31
RS-232 PROTOCOL	31
TROUBLE SHOOTING	32
SPECIFICATIONS	33

6. *APPENDIX*

APPENDIX A – INSTALL THE HDD	34
APPENDIX B – REPLACE THE HDD	34
APPENDIX C – PIN CONFIGURATIONS	35
APPENDIX D – RECORDING SPEED	36
APPENDIX E – NETWORK APPLICATION	38

What do you get ?

FEATURES

- MPEG-2 compression format
- USB Backup (backup files by USB Flash Drive and USB HDD devices).
- High resolution: 720 X 480 pixels <NTSC> 720 x 576 pixels <PAL>
- Duplex function (record and playback)
- Picture-in-Picture (PIP) in live
- Motion detection function
- Alarm input & output function
- Video loss detected on each channel
- Linear Zoom (2x)
- Recording rate: Up to 30 frames/sec (NTSC) ; Up to 25 frames/sec (PAL).
- Support 1 HDD, IDE TYPE
- Quick multiple search by event / time list
- Security password protection

PACKAGE CONTENT

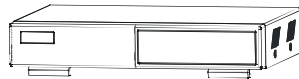

Digital Video Recorder
(with HDD cartridge)



User's Manual



Power Adaptor and Cord



Accessories pack



HDD screws

Warning:

1. Please check the package to make sure that you receive the complete accessories shown above.
2. The adaptor is DC19V 2A. If it is damaged, users can find replacement adaptor locally with this specification.

INSTALLATION GUIDE

1. Shown below is an example of connecting the DVR to existing Observation System.
2. Install HDD (The compatible HDD models are listed in the following table).

Please refer to page.34 Appendix A for installation instructions.

Note: 1. The HDD must be installed before turning on the DVR. If HDD is not installed, the DVR would function as a 4 CH multiplexer.

2. Users need to set the HDD on the Master mode for system detecting.

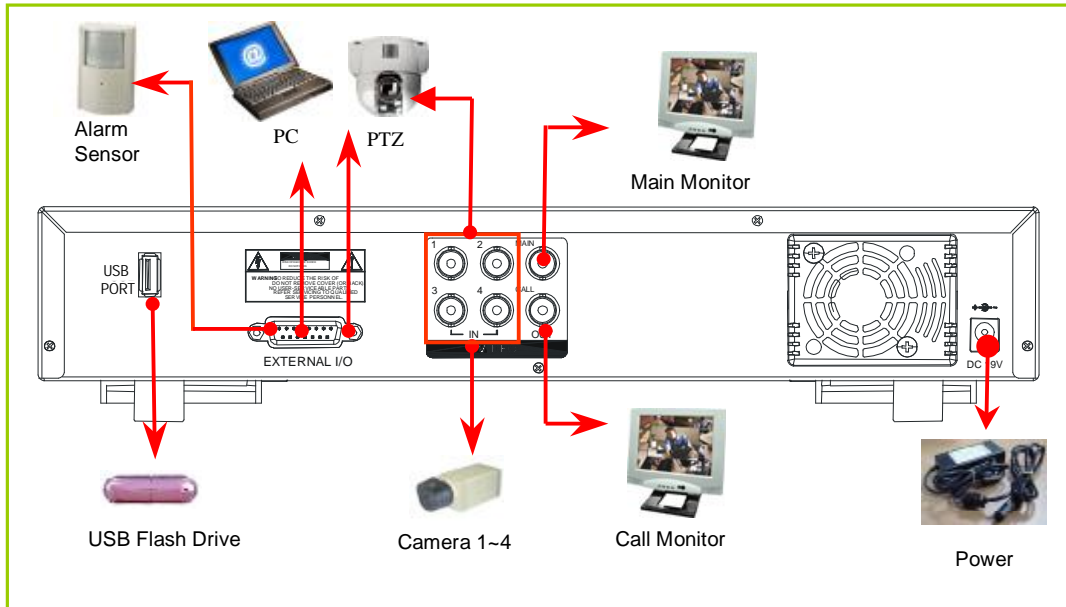

COMPATIBLE HARD DISK MODELS

Manufacturer	Model	Capacity	Rotation
HITACHI	Deskstar 180 GXP (120 GB)	120GB	7200 rpm
HITACHI	Deskstar 7K250, HDS722516VLAT20	160GB	7200 rpm
HITACHI	Deskstar 7K250, HDS722525VLAT80	250GB	7200 rpm
IBM	Deskstar 120GXP (80GB)	80GB	7200 rpm
IBM	Deskstar 120GXP (120GB)	120GB	7200 rpm
Maxtor	DiamondMax 536DX(60GB) 4W060H4	60GB	5400 rpm
Maxtor	DiamondMax Plus 9	80GB	7200 rpm
Maxtor	DiamondMax Plus 9, Model#6Y120L	120GB	7200 rpm
Maxtor	DiamondMax Plus 9, Model#6Y160L0	160GB	7200 rpm
Maxtor	MaxLine Plus II , Model#7Y250P0	250GB	7200 rpm
Seagate	Barracuda ATA IV, ST380021A	80GB	7200 rpm
Seagate	Barracuda ATA V, ST3120023A	120GB	7200 rpm
Seagate	Barracuda 7200.7 Plus, ST3160023A	160GB	7200 rpm
Western Digital	Caviar WD1200BB-00CAA1	120GB	7200 rpm
Western Digital	Caviar WD2000BB-00DWA0	200GB	7200 rpm
Western Digital	CaviarSE WD2500JB	250GB	7200 rpm

NOTE: For non-stop long-time recording, we suggest to have two HDDs for recording to ensure good reliability of HDD.

FRONT PANEL

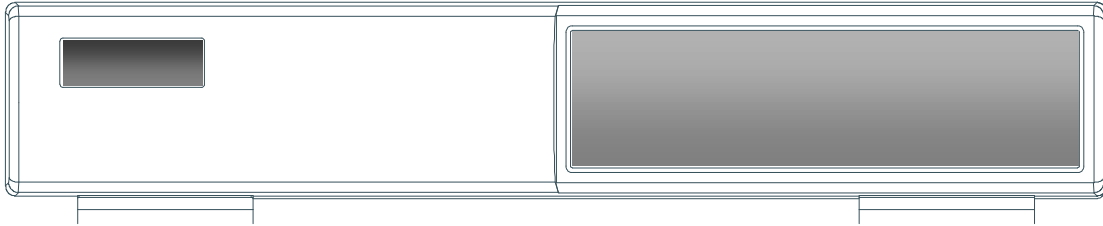

▶ 1. LED LIGHT

The LED Light is ON under following conditions.

- HDD : HDD is reading or recording.
- HDD Full : HDD is full
- ALARM : To turn off the ALARM LED light, please refer to page.15 and set the ALARM mode as OFF.
- TIMER : When Timer is Enabled
- PLAY : Playing mode
- REC : Recording mode

▶ 2. MENU

Press MENU to enter main menu.

▶ 3. ENTER

Press ENTER for confirmation

▶ 4. SEARCH

Press SEARCH for searching recorded video.

▶ 5. ZOOM



Press the ZOOM button Enlarge the picture (2X).

▶ 6. /+ Picture in Picture

PIP: Press "PIP" button for Picture in Picture screen.

+ : Press "+" button can change the setting in the menu.

▶ 7. /- 4-channel display mode

 : Press "" button for 4 CH display modes

- : Press "-" button can change the setting in the menu.

▶ **8. SLOW**

To slow down the speed of playing mode.

▶ **9. FF / ▶**

- FF : Play video fast forward. (Press FF button again to adjust speed as 3, 45, 600 times)
- ▶ : Under setup mode, it works as Right button.

▶ **10. REW / ◀**

- REW : Play video fast backward. (Press REW button again to adjust speed as 15, 90, 600 times)
- ◀ : Under setup mode, it works as Left button.

▶ **11. STOP / ▼**

- STOP : Under DVR Play mode, it can stop the action.
- ▼ : Under setup mode, it works as Down button.

▶ **12. PAUSE / ▲**

- Pause : Under DVR play mode, it can pause the action.
- ▲ : Under setup mode, it works as Up button.

▶ **13. PLAY**

Press PLAY to playback recorded video.

▶ **14. REC**

Press REC to start recording.

▶ **15. CAMERA SELECT (1-4)**

Press the Camera Select (1-4) to select the channel.

▶ **16. ENTER + SEARCH**

Press both “ENTER” + “SEARCH” buttons to enter the USB Backup menu.

▶ **17. ENTER + MENU**

Key Lock (and Key Unlock).

▶ **18. ENTER + ZOOM**

PTZ control enable/disable.

REAR PANEL

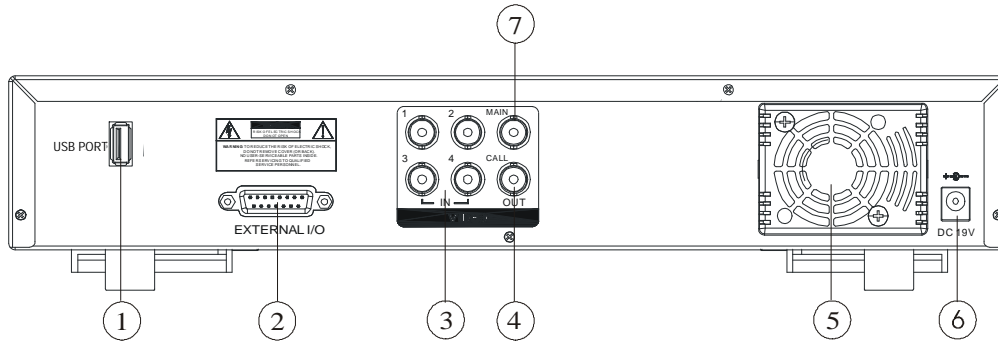

▶ 1. USB

Connect to a USB HDD or a USB Flash Drive.

▶ 2. EXTERNAL I/O

- Controlled remotely by an external device or control system such as Video Web Server or PC.
- Alarm input, external I / O expansion.

▶ 3. VIDEO INPUT (1-4)

Connect to video source, such as camera.

▶ 4. CALL

Connect to CALL monitor. Show the Switch Display.

When alarm trigger happens, it will change to dwell modes of alarm(refer to p.18)

▶ 5. FAN

For ventilation, do not block the opening.

▶ 6. POWER

Please use the provided power cord.

▶ 7. MAIN

Connect to the main monitor.

Warning:

1. The adaptor is only for this machine. Do not use it for other electronic product or it might damage other products.
2. The adaptor is DC19V 2A. If it is damaged, users can find replacement adaptor locally with this specification.

Basic Operation

GETTING STARTED

Before using the DVR, please have a HDD installed ready; otherwise, it will function as a 4 CH multiplexer (refer to Appendix A and Appendix B for installation or removal of a HDD).



1. Connect the AC power cord and plug into an electrical outlet. The power LED indicator light will be on.
2. It takes approximately 5 to 15 seconds to boot the system with the message: "Booting". The Power LED will turn from orange to green and Alarm LED will be on.
3. Before operating the DVR, set the system time first. (refer to page 20).

NOTE : 1. If the HDD is not installed correctly or not installed, "NO HDD!", "HDD KEY UNLOCK!", "UNKNOWN FILE SYSTEM! PLEASE FORMAT IT!" messages will appear for 3 seconds, and then return to 4 CH Multiplexer display mode.

*** "UNKNOWN FILE SYSTEM!": The format of HDD is not accepted by the DVR system. The system only accepts EXT3 format. Users can format HDD by selecting "HDD FORMAT" on SYSTEM menu.

2. To switch the system, you need to unplug the AC power, then press "FF" button or "REW" button and connect the AC power cord, it will switch to NTSC system or PAL system. And the DVR will be auto-detecting.

OPERATION

RECORDING

The DVR offers 2 recording modes(Timer, Manual). Under the recording status, if power is off accidentally, the recorded video will still be stored in the HDD. DVR will return to previous recording setting after power restores.



Ab 007.2 GB

The first character: (Frame/Sec)

A : 30 <NTSC> 25 <PAL>

B : 15 <NTSC> 12 <PAL>

C : 5 <NTSC> 4 <PAL>

The second character: (Record Quality)

a : Best b : High c :Normal d : Basic

007.2 GB: the available space of HDD is
O/W: HDD is overwritten

NOTE : Under O/W Recording mode, previously recorded files will be automatically overwritten.
There are two recording modes: Timer and Manual Recording.

1. TIMER RECORDING

Recording is scheduled by a Timer. It will be indicated by the symbol .

2. MANUAL RECORDING

Recording is initiated manually by pressing the REC button. Symbol  will be shown.

If the system is shut down, the system will resume recording automatically.

Note: To prolong the life span of HDD, please confirm that the power of the machine is off before unplugging the power cord. Moreover, if the power system is unstable, we suggest installing UPS.

PLAY BACK

Press the "PLAY" button to display the last video.

The screen will display the last video of a channel which is in display.

When all channels are on screen display, and users press the "PLAY" button, the menu (PLAY MODE) will show up for users to select channels.



When changing the channels, users can either press the buttons "1- 4" on the front panel or enter the "PLAY MODE" menu for displaying.



Press "ENTER" button to enlarge the video to full screen.

1. FF (FAST FORWARD) & REW (FAST REWIND)

Increase the speed of Fast Forward and Rewind on the DVR by pressing the “FF” button.

In the Play mode, press “FF” once to get 3X speed forward and press twice to get 45X speed, and the maximum speed can reach 600X.

Press “REW” once to get 15X speed rewind and press twice to get 90X speed, and the maximum speed can reach 600X.

2. SLOW FORWARD

Slow down the speed of Forward on the DVR by pressing the “SLOW” button.

In the Play mode, press the “SLOW” button to enter the Slow mode.

Press “SLOW” once to get 1/4X speed forward and press “SLOW” to get 1/8 speed,... and the slowest speed can reach 1/16X.

3. PAUSE

The still image will be displayed on the screen. (Please refer to page.11 for “STOP RECORD”.)

4. STOP

Press “STOP” button to stop displaying a video.

5. IMAGE JOG DIAL

It will allow you to manually view video frame-by-frame, one image at a time.

In PLAY mode, press “PAUSE”, it will let the video pause.

Press “▶” button advances one image.

Press “◀” button moves back one image.

■ Detailed Menu Setup

MAIN MENU

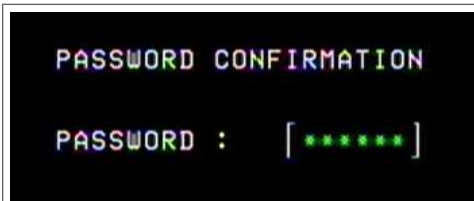

Press “MENU” button to enter the main menu at first time.
The default password is 000000.

There are 7 options available in the Main Menu.

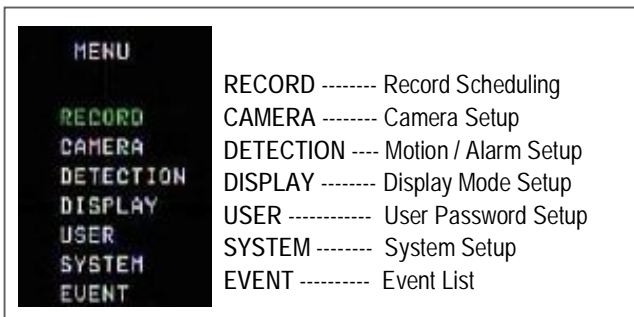

Outlined below are the buttons used for Menu setting :

- “▲” “▼” “◀” “▶” : Move the cursor.
- “+” and “-” : Select the numbers/ change values.
- ENTER : Enter a submenu mode / an option under a submenu for browsing / Confirm the selection.
- MENU : Enter the menu mode / Confirm the change/ Exit a menu.

MAIN OPTIONS

RECORD



Press the “▲” “▼” “◀” “▶” buttons to move the cursor.

Press the “+” “-” buttons to change the digit.

Press the “MENU” button to confirm the changes/ to exit the menu.

1. STOP RECORD(MANUAL RECORD)

The system will stop manual recording function during the recording period if the setting is “YES”. And then, press the “ENTER” button to save the changed value.

Note: 1. The users have to stop recording function on this menu because the users cannot stop it by pressing any front-panel buttons during the recording period.

2. In the Timer Recording mode, users have to either change the RECORD METHOD setting from TIMER to MANUAL or change the timer setting to stop the timer recording function.

2. FRAME / SEC

Select the recording speed. The options are as following :

NTSC — 30 、 15 、 5 PAL — 25 、 12 、 4

3. QUALITY

There are four image qualities : BEST, HIGH, NORMAL, BASIC.

4. HDD OVERWRITE

To set the HDD OVERWRITE. When the HDD is going to be full under O/W recording mode, previous recorded files will be overwritten without further warning notices if the HDD OVERWRITE is “ON”.

5. RECORD METHOD

There are two recording methods: MANUAL (by pressing the “REC” button) and TIMER (by setting the timer recording).

***On the Timer Recording mode, users have to either change the RECORD METHOD setting from TIMER to MANUAL or change the timer setting to stop the timer recording function.

TIMER SETUP



Press “▲” “▼” “◀” “▶” buttons to move the cursor.

Press “+” “-” buttons to change the digit.

Press “MENU” button to confirm the changes/ to exit the menu.

1. DAY

Choose the day for recording. The options are:

MON(Monday) , TUE (Tuesday), WED (Wednesday), THU (Thursday), FRI (Friday), SAT (Saturday),
SUN (Sunday), MO-FR (Monday to Friday), SA-SU (Saturday to Sunday), OFF, and DAILY(on each day).

* Date could be changed by “+” and “-” buttons.

2. START

The beginning of recording time.

3. END

The end of recording time.

NOTE: If users want to record a video from 11 p.m. to 2 a.m. , and users need to set two different periods for recording. The first period will be 23 to 24, the second period will be 0 to 2. The number of ending time must be greater than the number of beginning time.

CAMERA

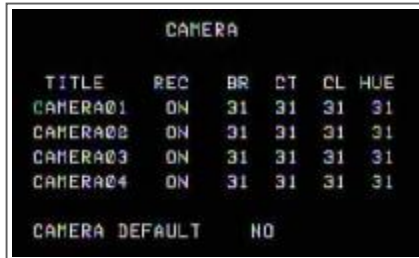

CAMERA					
TITLE	REC	BR	CT	CL	HUE
CAMERA01	ON	31	31	31	31
CAMERA02	ON	31	31	31	31
CAMERA03	ON	31	31	31	31
CAMERA04	ON	31	31	31	31
CAMERA DEFAULT		NO			

Press the “◀” “▶” buttons to move the cursor.

Press the “+” “-” buttons to change the option/digit.

Press the “MENU” button to confirm the changes/ to exit the menu.

1. TITLE

Assign a title to each channel. The default title is the camera's number (Up to 8 characters).

2. REC (RECORD)

Select a channel to record.

ON : when the timer input is triggered, DVR will record a video.

OFF : DVR will not record.

3. BR (BRIGHTNESS)

Adjust the brightness of each channel. The level is from 0 to 63.

4. CT (CONTRAST)

Adjust the contrast of each channel. The level is from 0 to 63.

5. CL (COLOR)

Adjust the color of each channel. The level is from 0 to 63.

6. HUE (HUE)

Adjust the hue of each channel. The level is from 0 to 63.

7. CAMERA DEFAULT

The setting of BR/CT/CL/HUE will go back to the default value, which is 31, when users press “camera default”.

DETECTION

Press the “▲” “▼” buttons to move the cursor.

Press the “+” “-” buttons to change the option.

Press the “MENU” button to confirm the changes/ to exit the menu.



1. DET (DETECTION)

The motion detection on each channel can be turned ON or OFF individually.

2. AREA

Press the “ENTER” button to set target-area.

In this function, it is defaulted to detect the whole area.

After entering the setting, users will see the pink area, which means the undetected area, and users can set the area to be detected, and which will turn from pink to transparent.

The Pink target represents the undetected area.

The Transparent target represents the Motion Detection Area.



*The beginning of Motion Detection Setting-
Detect all targets*



*Motion Detection Setting-
One Target undetected*

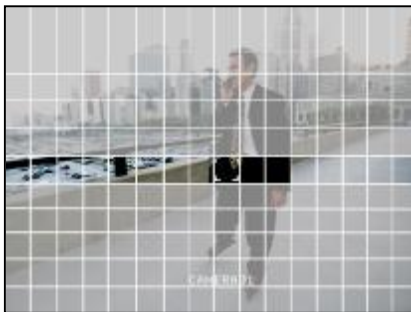

*Motion Detection Setting-
A row-target detected*

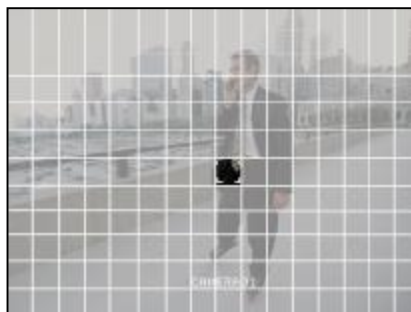

*Motion Detection Setting-
A detected target*

▲▼◀▶: navigates between targets.

- : turns all targets on the screen ON/ OFF.

+ : press once to set a motion target, press twice to set a row of motion target.

3. LS (Level Sensitivity)

Comparing the difference between two images to allow the system to start motion detection function.

Lower number = higher sensitivity for motion detection. The highest sensitivity setting is 0, the lowest sensitivity setting is 15. The default value is 06.

4. SS (Spatial Sensitivity)

Set the number of motion detection targets (from 1-99 target areas). The highest sensitivity setting is 0, the lowest sensitivity setting is 15. The default setting is 01.

Note: The setting of Spatial Sensitivity cannot be more than the number of targets set in the AREA.

5. TS (Temporal Sensitivity)

The system will start the motion detection function if the continuous fields are all different.

The highest sensitivity setting is 0, the lowest sensitivity setting is 15. The default setting is 01.

6. RE (Reference)

Set the Reference image to which the current screen is compared (from 0-63).

For example, the value 8 would compare the current image to the 8th previous image. The higher value will increase the sensitivity. The default value is 10.

7. ALARM

Select LOW / OFF / HIGH for alarm polarity. The default alarm value is OFF.

8. EVENT DURATION

Set the event duration time.

9. DAY. START. END of Detection

Choose the day for recording, the beginning of recording time and the end of recording time.

Note: When the motion detection function is triggered during the recording period. The symbol will be shown .

When the alarm function is triggered during the recording period. The symbol will be shown .

DISPLAY



Press the “▲” “▼” “◀” “▶” buttons to move the cursor.

Press the “+” “-” buttons to change the option/digit.

Press the “MENU” button to confirm the changes/ to exit the menu.

1. TITLE DISPLAY

Set the title shown on monitor.

2. OSD COLOR

Select the OSD (On Screen Display) color. The options are WHITE, RED, YELLOW, CYAN, BLUE, PINK, GRAY, ORANGE.

3. CURSOR COLOR

Select the cursor color. The options are RED, YELLOW, GREEN, CYAN, BLUE, PINK, GRAY, ORANGE .

NOTE: The setting of OSD COLOR and CURSOR COLOR cannot be the same.

4. LOSS SCREEN

Select a way to display the screen when the video input is out of order. The options are BLACK, BLUE and RETAIN (retain the last picture).

5. OSD POSITION

Select the OSD POSITION. The options are NORMAL (in upper right corner) or CENTER.

6. PLAYBACK METHOD

Select a video type to playback. The options are frame and field. 1 frame equals two fields.

7. PIP OPTION / DWELL OPTION(see p.17,18)

To enter the PIP setting menu/DWELL setting menu.

PIP OPTION

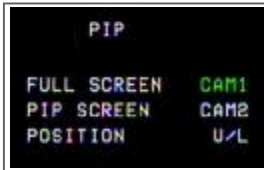

Press the “▲” “▼” buttons to move the cursor.

Press the “+” “-” buttons to change the option.

Press the “MENU” button to confirm the changes/ to exit the menu.

1. FULL SCREEN

The full screen background picture display.

2. PIP SCREEN

The picture with a 1/9 size screen “insert”.

3. POSITION

There are six position settings : D/L (Down/Left), D/M (Down/Middle), D/R (Down/Right), U/L (Up/Left), U/M (Up/Middle), U/R (Up/Right).

DWELL OPTION



A screenshot of a video management system menu titled "DWELL". The menu is displayed on a black background with white and green text. It lists four camera channels: CAMERA01, CAMERA02, CAMERA03, and CAMERA04. For each camera, there are two columns: "NORM" and "ALARM". The "NORM" value for CAMERA01 is 05 (highlighted in green), while for the others it is 02. The "ALARM" value for all cameras is 02.

	NORM	ALARM
CAMERA01	05	02
CAMERA02	02	02
CAMERA03	02	02
CAMERA04	02	02

Press the “▲” “▼” “◀” “▶” buttons to move the cursor.

Press the “+” “-” buttons to change the option.

Press the “MENU” button to confirm the changes/ to exit the menu.

1. NORM

To set up the DWELL time period that each channel auto sequentially shows on call monitor. The level is from 01 to 24 Sec or OFF.

2. ALARM

To set up the DWELL time period when alarm input is triggered.

The level is from 01 to 24 Sec or OFF.

USER



USER	
SUPERVISOR	PASSWORD
USER1	000001
USER2	000002
USER3	000003
USER4	000004
USER5	000005
USER6	000006

Press the “▲” “▼” “◀” “▶” buttons to move the cursor.

Press the “+” “.” buttons to change the option/digit.

Press the “MENU” button to confirm the changes/ to exit the menu.

1. USER

To set up the user’s account for controlling. It allows 7 users setting.

Supervisor – Control all the functions.

Other Users – View all functions except the menu setting and event list cleaning.

2. PASSWORD

To set the security password for each account.

The maximum length of user’s password is 6 digits.

SYSTEM



Press the “▲” “▼” “◀” “▶” buttons to move the cursor.

Press the “+” “-” buttons to change the setting

Press the “MENU” button to confirm the changes/ to exit the menu

1. KEY MUTE

To set the KEY MUTE. When the setting is “ON”, there will be no sound when you press any key.

2. BUZZER (see p.22)

To enter the buzzer setup menu.

3. MESSAGE LATCH

The default setting of messages displaying is 10 seconds when the setting is “ON”.

4. DATE DISPLAY

Set the date display. The options are Y/M/D, D/M/Y, M/D/Y and OFF.

5. DATE

Set the date.

6. TIME

Set time.

7. HDD FORMAT

Format HDD by selecting “FORMATE” option. After formatting the HDD, the system will restart.



Note:1. The system will take about 12minutes to format 80GB HDD.

If the HDD have been formatted before, it takes about 4 minutes to format it.

2. After formatting the HDD, you would find that the space about 12% is occupied.

8. SYSTEM RESET

Reset all system settings back to factory default setting.

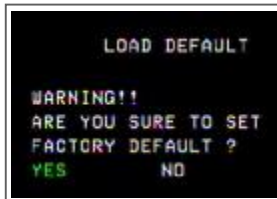

9. LANGUAGE

Select one language for menu displaying. The options are ENGLISH and CHINESE. The system will automatically save the setting.

10. UPGRADE(see p.24)

To enter the upgrade setup menu.

11. REMOTE(see p.23)

To enter the remote setup menu.

BUZZER SETUP

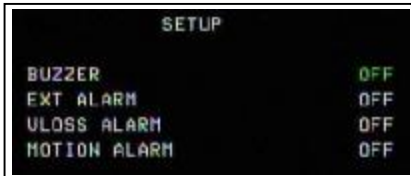

1. BUZZER

Set the BUZZER "ON", it will buzz when event occurs.

2. EXT ALARM

To set the EXT ALARM. It will be triggered by event occurrence when the setting is "ON".

3. VLOSS ALARM

To set the VLOSS ALARM. When the setting is "ON", the alarm will start after setting Buzzer, EXT Alarm or Alarm Duration.

4. MOTION ALARM

To set the MOTION ALARM. When the setting is "ON", the alarm will start after setting Buzzer and EXT Alarm.

REMOTE SETUP



Press the “▲” “▼” buttons to move the cursor.

Press the “+” “-” buttons to change the option.

Press the “MENU” button to confirm the changes/ to exit the menu.

1. REMOTE MODE

Set the remote mode for connection with computer via RS-232 or RS-485.
(refer to page. 30 for RS-232 & RS-485 Remote Control).

2. BAUD RATE

Set the remote protocol transmitting baud rate. Available options are
115200, 57600, 19200, 9600, 4800, 2400, 1200.

3. ID

To control different DVR by setting remote protocol. ID number can be set from 000 to 254.

UPGRADE SETUP



User can upgrade the DVR software by USB storage device.

YES: Upgrade

No : Cancel

It will take few minutes to upgrade the whole system. Users cannot unplug the power cord, or turn off the power during the period of upgrading.

It will reset the system setting will be disable when the system is upgraded. Therefore, the users have to reset all settings after upgrading.

CHECK CRC: The system will check the firmware status to ensure the quality of system.



EVENT



Press the “▲” “▼” buttons to move the cursor.

Press the “ENTER” button to get into the submenu

The EVENT shows the recording list of different types.

The VLOSS section lists the record of video loss.

The ALARM LOG section lists the record of triggering by external I/O alarm.

The MOTION LOG section lists the record of triggering by motion detection.

The ALL LOG section lists all types of records.

The DELETE ALL option will delete all records.

```
EVENT 1/7
CH ACTION YEAR-MON-DAY HO:MI:SE
KEY LOCK 2000-JAN-01 01:33:35
KEY UNLOCK 2000-JAN-01 01:33:37
KEY LOCK 2000-JAN-01 01:33:39
KEY UNLOCK 2000-JAN-01 01:33:41
CH4 VLOSS 2000-JAN-01 01:33:51
CH4 VLOSS 2000-JAN-01 01:33:53
CH3 VLOSS 2000-JAN-01 01:33:55
KEY LOCK 2000-JAN-01 01:34:24
KEY UNLOCK 2000-JAN-01 01:34:26
PWR RESET 2000-JAN-01 01:37:05
PWR RESET 2000-JAN-01 01:39:20
PWR RESET 2000-JAN-01 01:43:00
```

A single page can display 12 recorded events.

Press “◀” or “▶” button to change the pages(Up to 256 records).

PWR RESET: The system will automatically record when the system has been reset.

Advanced Operation

OPERATION OPTIONS

2X ZOOM

Press the “ZOOM” button, it displays zoomed picture on main picture and a small inserted window. The inserted window contains a movable 1/4 view size of the appointed camera. The range is 2X.



- Press the “ZOOM” button again to exit the zoom pointer.
- Press Camera 1-4 button to select a channel.
- Press ▲▼◀▶ buttons to move the zoom position.

VLOSS (VIDEO LOSS)

The screen will display “VLOSS” in the center of display picture, if the video input is not connected properly.



SEARCH

Press "SEARCH" button to play the recording.



Select a channel for searching a video record.

Press "▲" "▼" buttons to select camera.

Press the "ENTER" button to get into menu/ submenu

Press the "MENU" button to confirm the changes/exit the menu

[SEARCH MODE]



Press the "ENTER" button to get into each submenu.

1. EVENT SEARCH

Display all the videos, which have been motion triggered on the recording mode.

2. TIME SEARCH

Enter a time period for searching a video.

3. LIST ALL

List all video records.

	Y / M / D	HO:MI:SE	MI:SE	TYPE
631	2004/08/28	05:20:00	10:00	D1
632	2004/08/28	05:30:01	09:59	D1
633	2004/08/28	05:40:00	10:00	D1
634	2004/08/28	05:50:01	09:59	D1
635	2004/08/28	06:00:00	10:00	D1
636	2004/08/28	06:10:00	06:43	D1
637	2004/08/30	10:41:12	00:03	D1
638	2004/08/30	10:41:15	00:27	D1
639	2004/08/30	10:41:48	00:22	D1
640	2004/08/30	10:42:14	00:06	D1

Press the “▲” “▼” buttons to select one record.

Press the “ENTER” / “PLAY” buttons to display.

1. Y/M/D

The Month and the Date display(Year/Month/Date).

2. HO:MI:SE

The beginning of recording time(Hour:Minute:Second).

3. MI:SE

The duration of playing time(Minute:Second).

4. TYPE

D1: Multiplex mode (input images of a channel at a time).

USB BACKUP



Users may have to format the USB memory device(USB Sticker and USB HDD devices) by PC before connecting to the DVR.

Press both “ENTER”+ “SEARCH” buttons, enter the USB BACKUP mode.

Users can save files into the USB storage device, and read files by personal computer.

The system will detect the USB storage device automatically. it will show “DETECTING USB DEVICE”

The symbol [] shows the available space of the USB storage device.

And press “ENTER”, you can see this screen.



Press “◀” “▶” buttons to select a channel or move to the next digit.

Press “+” “-” buttons to change the digit.

Step 1: Choose a certain camera by pressing “◀” “▶” buttons.

Step 2: Enter the beginning and the end of time by pressing “+” “-” buttons.

Step 3: Select OK by pressing “ENTER” button (shows the recording space).

Step 4: Select OK again to start to backup a file.

[]/[]: [Recording space] / [Total available space of the USB memory device].

NOTE:

1. The USB memory device can only be detected by these three file types:

FAT32 (WINDOWS), EXT3 (LINUX), EXT2 (LINUX)

2. The system will take a few minutes to search if the file is too large.

3. The backup files can only be read by WinDVD and PowerDVD software.

KEY LOCK

For advanced security, users can “Lock” the buttons on your DVR. Key-Lock prevents other people from using the system.

Press “ENTER” + “MENU” at the same time to enable Key Lock.

Press “ENTER” + “MENU” at the same time and key in password (Default : 000000), and then press “ENTER“ to disable Key Lock.

NOTE: To switch to different USER, press “ENTER” + “MENU” buttons to “KEY LOCK” and then enter the different user’s password to UNLOCK.

RS-232 REMOTE PROTOCOL

You can use the PC keyboard to simulate DVR keypad.

DATA: REMOTE PROTOCOL using 8 bit data · 1 start bit · 1stop bit

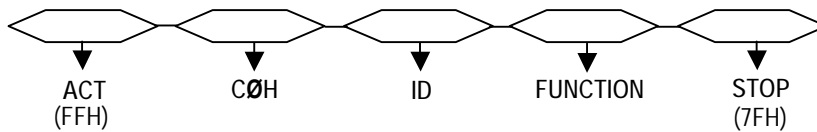

FUNCTION	CODE	ASCII	FUNCTION	CODE	ASCII
KEY_MENU	0x4D	M	KEY_PLAY	0x50	P
KEY_SEARCH	0x73	s	KEY_DOWN	0x4E	N
KEY_ENTER	0x0D	ENTER	KEY_RIGHT	0x52	R
KEY_QUAD	0x51	Q	KEY_POWER	0x57	W
KEY_ZOOM	0x5A	Z	KEY_KEY_LOCK	0x4B	K
KEY_PIP	0x70	p	KEY_CH1	0x31	1
KEY_SLOW	0x53	S	KEY_CH2	0x32	2
KEY_REC	0x72	r	KEY_CH3	0x33	3
KEY_LEFT	0x4C	L	KEY_CH4	0x34	4
KEY_UP	0x55	U			

TROUBLE SHOOTING

When malfunction occurs, it may not be serious and can be corrected easily. The table below describes some typical problems and their solutions. Please check on them before contacting your DVR dealer.

PROBLEM	SOLUTION
No power	I Check power cord connections.
	I Confirm that there is power at the outlet.
Not working when pressing any button	I Check if it is under Key Lock mode.
	I Press " MENU " & " ENTER " to exit Key Lock mode.
No recorded video	I Check if the HDD is installed properly.
Timer Record enable does not working	I Check if the Record Enable is set to YES
No live video	I Check camera video cable and connections.
	I Check monitor video cable and connections.
	I Confirm that the camera has power.
	I Check the setting of camera lens.
NTSC & PAL System switch	To switch the system, you need to unplug the AC power, then press "FF" or "REW" and plug in the AC power cord again. (Please refer to page.6)
Under overwriting and duplex modes, the playback motion is interrupted	please press "STOP" button and then the "PLAY" button to play again

SPECIFICATIONS

Video Format	NTSC/EIA or PAL/CCIR
Hard Disk Storage	IDE type, UDMA 66, supported a over 250 GB HDD
Resolution	720 x 480 pixels <NTSC> , 720x576 pixels <PAL>
Recording Mode	Manual / Timer
Camera Input Signal	Composite video signal 1 Vp-p 75Ω BNC, 4 channels
Main Monitor Output	Composite video signal 1 Vp-p 75Ω BNC
Call Monitor Output	Composite video signal 1 Vp-p 75Ω BNC
USB Interface	1 port. Support USB 1.1 Device
Motion Detection Sensitivity	16 Levels
Video Loss Detection	Yes
Refresh Rate	120 frames/sec. for NTSC / 100 frames/sec. for PAL*
Recording Rate	Up to 30 frames/sec. for NTSC / 25 frames/sec. for PAL
Dwell Time	Programmable (1~24 Sec)
Picture in Picture	Yes (Movable)
Key Lock	Yes
Picture Zoom	2X (Movable)
Camera Title	8 letters
Video Adjustable	Hue/ Color/ Contrast/ Brightness Adjustable
Alarm Input	TTL input, High (5V), Low (GND)
Alarm Output	COM./N.O/N.C
Remote Control	RS-232 or RS-485
Time Display Format	YY/MM/DD, DD/MM/YY, MM/DD/YY, OFF
Power Source	DC 19V
Power Consumption	<32W
Operation Temperature	10 ~ 40°C
RS-232C / RS-485 (bps)	115200 、 57600 、 19200 、 9600 、 4800 、 2400 、 1200
Dimension (mm)	343(W) x 223(L) x 59(H)
Net Weight	2 kg

* Specifications are subject to change without notice.

*NTSC: 4CH x 30IPS = 120 frames/sec, PAL: 4CH x 25IPS = 100 frames/sec



APPENDIX A— INSTALL THE HDD

Follow these steps carefully in order to ensure correct installation.



Fig. 1



Fig. 2



Fig. 3



Fig. 4



Fig. 5

Step 1 Remove the lid and unscrew the screws from HDD bracket module .

Step 2 Insert the HDD into the HDD bracket and screw the four screws. (refer to the Fig. 1, Fig. 2).

Step 3 Connect the HDD power cable to the HDD (refer to the Fig. 3).

Step 4 Attach the HDD connector to the 40-pin cable, and screw the HDD and the DVR machine together (refer to the Fig. 3).

Step 5 Pull the sides of the lid apart slightly and push the lid down (refer to the Fig. 4).

Note: Do not try to retrieve the HDD data by PC. The video file cannot be read by PC, operation on PC would damage the FAT table of the hard disk.



APPENDIX B— REPLACE THE HDD

Follow these steps carefully in order to ensure correct installation.



Fig. 1



Fig. 2



Fig. 3



Fig. 4



Fig. 5

Step 1 Remove the lid (refer to the Fig 1).

Step 2 Remove the HDD power cable from the HDD (refer to the Fig. 3).

Step 3 Take out the HDD from DVR machine carefully.

Step 4 Unscrew the four screws connected the hard drive to the bracket and remove the HDD bracket module. Repeat those steps according to the “Install the HDD” section for resetting another HDD (refer to the Fig 4).

Step 5 Pull the sides of the lid apart slightly and push the lid down.

Note: When HDD works for a period of time, the surface temperature will be high, please notice it.



APPENDIX C— RECORDING SPEED

The Recording Time is different based on Recording Speed, Recording Quality and Recording Mode. Please refer to the following table. HDD capability is 250GB.

NTSC SYSTEM

IPS		30	15	5
Multiplex Mode	Best	106hr	212hr	636hr
	High	132hr	264hr	792hr
	Normal	213hr	426hr	1278hr
	Basic	326hr	652hr	1956hr
HDD Type	250 GB			

PAL SYSTEM

IPS		25	12	4
Multiplex Mode	Best	106hr	212hr	636hr
	High	132hr	264hr	792hr
	Normal	213hr	426hr	1278hr
	Basic	326hr	652hr	1956hr
HDD Type	250 GB			



APPENDIX D—PIN CONFIGURATIONS

15 pin com port

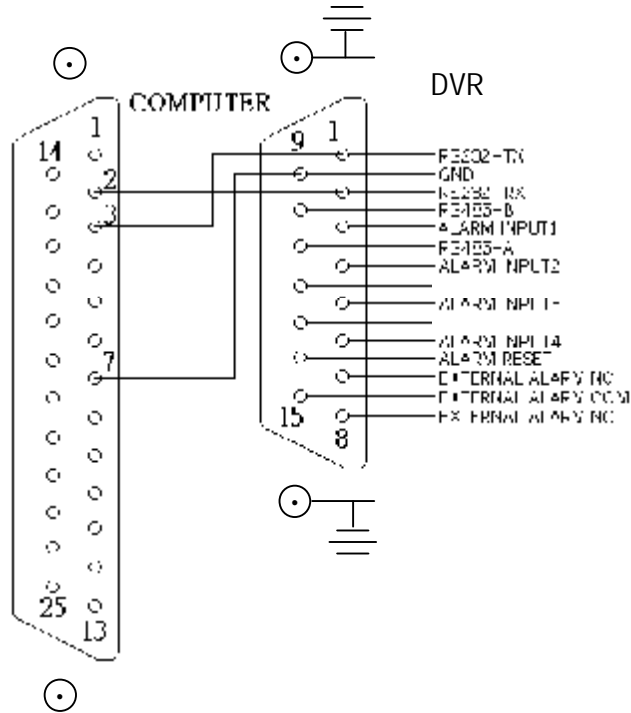

9 pin com port

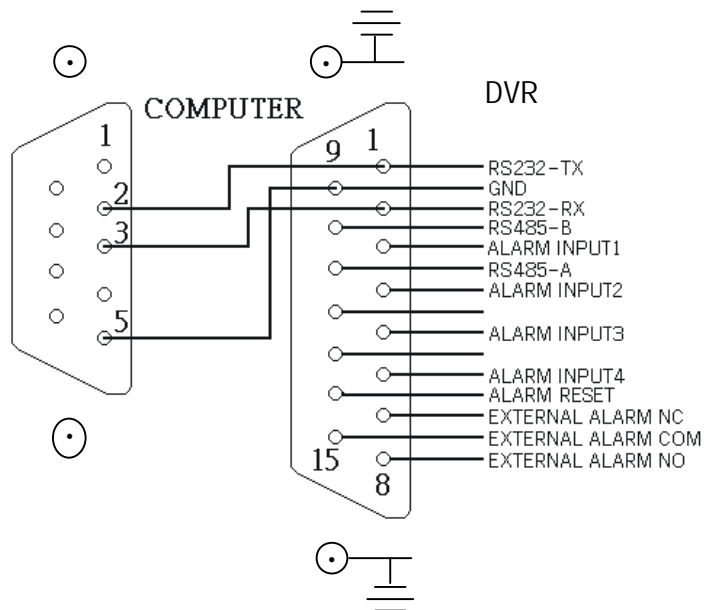

PIN 1. RS232-TX : RS-232

DVR can be controlled remotely by an external device or control system, such as a control keyboard, using RS-232 serial communications signals.

PIN 2. RS232-RX : RS-232

DVR can be controlled remotely by an external device or control system, such as a control keyboard, using RS-232 serial communications signals.

PIN 3, 4, 5, 6 ALARM INPUT

To connect wire from ALARM INPUT (PIN 3, 4, 5, 6) to GND (PIN 9) connector. When alarm has been triggered, signal becomes "Low", and it will stop all alarm activities. Under normal operation, signal remains "High".

PIN 7. EXTERNAL ALARM NC

Under normal operation COM connect with NC and disconnect from NO. But when alarm is triggered, COM disconnect with NC, and connect with NO.

PIN 8. EXTERNAL ALARM NO

Under normal operation, COM will disconnect from NO. But when Alarm is triggered, COM will connect with NO.

PIN 9. GND

GROUND

PIN 10. RS485-B

DVR can be controlled remotely by an external device or control system, such as a control keyboard, using RS-485 serial communications signals.

PIN 11. RS485-A

DVR can be controlled remotely by an external device or control system, such as a control keyboard, using RS-485 serial communications signals.

PIN 14. ALARM RESET (INPUT)

To connect wire from ALARM RESET (PIN 14) to GND (PIN 9) connector, it can disable ALARM. An external signal to ALARM RESET (PIN 14) can be used to reset both ALARM OUTPUT signal and DVR's internal buzzer. When alarm has been triggered, signal becomes "Low", and it will stop all alarm activities. Under normal operation, signal remains "High".

PIN 15. EXTERNAL ALARM COM

Under normal operation COM connect with NC and disconnect from NO. But when alarm is triggered, COM disconnect from NC, and connect with NO.



APPENDIX E— NETWORK APPLICATION

Video Web Server Features

- Compatible with most of CCTV Products; empower any video output device watching and controlling on the Internet or LAN
- Auto Network Reconnection (ANR)
- Upgrade firmware & AP from FTP site via Video Web Server
- Support Watch dog function
- Support Dynamic IP address via a router.
- Support 4 alarm inputs
- Duplex function, record and playback simultaneously at client site
- Auto e-mail warning system which will remind you if external alarm happens
- Intelligent non-stoppable recording function after ANR
- Support Multi AP screens Unique video player
- Alarm trigger recording function.



Video Web Server

DVR Control

- 1) Connect the Sub-D plug of Video Web Server with our own brand DVR products.

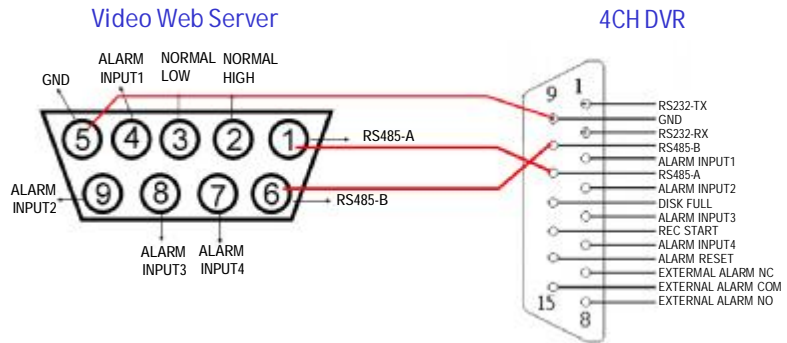

- 2) Set the "Remote" function in the DVR products.

NOTE : Remote mode : RS-485,
Baud rate : 2400, ID : same
as "I/O port setting" in the Video
Web Server.



- 3) Set the "I/O Port Setting" in the system config of Video Web Server.

Port1 : 4CH DVR, Device ID : 001.

