

Digital Multiplex Recorder

User Manual

776 V1.0

Table of Contents

1. Introduction

- 1-1 Safety Warning 3
- 1-2 Features 4
- 1-3 Specifications 5

2. Installation

- 2-1 Package contents 6
- 2-2 Connection 6
- 2-3 Rack mount installation 7
- 2-4 RS232 /RS485 Remote protocol 8

3. Configuration

- 3-1 Install HDD 9
- 3-2 Front panel keypad 11
- 3-3 Back panel connection 13
- 3-4 Menu setup 19
- 3-5 System setup 19
- 3-6 Search setup 25
- 3-7 TIMER setup (Schedule Time-Lapse record mode setup)..... 27
- 3-8 Record Setup 29
- 3-9 Camera setup 31
- 3-10 Motion Detection setup 33
- 3-11 Event 36

4. Operation

- 4-1 Power on 37
- 4-2 Recording 37
- 4-3 Camera Select (1-16) 38
- 4-4 Select..... 38
- 4-5 Picture in Picture..... 39
- 4-6 Zoom 39
- 4-7 Play 39
- 4-8 Video Loss 40
- 4-9 Key Lock 40

5. Trouble shooting & appendix

- 5-1 Trouble shooting 41
- 5-2 Compatible HDD brands 42

1. Introduction

Thank you for choosing this high quality Digital Multiplex Recorder. The DMR converts analog NTSC or PAL video to digital images and records them to a removable hard disk drive. Digitally recorded video has many advantages compared to analog video recorded on tape. There is no need to adjust tracking. Digital video can be indexed by time schedule or events, and you can instantly view video after selecting the time or event. You can freeze frames, fast-forward, fast-reverse, slow-forward, and slow-reverse without image streaking or tearing. It can be used as a replacement for both a time-lapse VCR and a multiplexer in a security installation.

1.1 Safety Warning

All the safety and operating instructions should be read before the operation. The improper operation may cause permanent damage.

- 1.1.1 Please use the provided adaptor.
- 1.1.2 Please lift and place this equipment gently.
- 1.1.3 Do not expose this equipment to open sunlight.
- 1.1.4 Do not use this equipment near water or in contact with water.
- 1.1.5 Do not spill liquid of any kind on the equipment.
- 1.1.6 Please power down the unit before unplugging.
- 1.1.7 This equipment should be operated only with power source from standard package.
- 1.1.8 Unauthorized repair or parts substitutions may result in fire, electric shock or other hazards.
- 1.1.9 Do not switch the Power On & Off within short period of time (within 3 seconds).
- 1.1.10 Do not attempt to service this equipment by yourself. Refer all servicing and repair to qualified service personnel.
- 1.1.11 This unit should be operated only from power source indicated on the manufacturer's label.
- 1.1.12 Installation should be made by a qualified service personnel and should conform to all local safety codes and regulations.

1.2 Features

1.2.1 Wavelet Compression Format replaces Time-Lapse VCR + Multiplexer

1.2.2 4 Audio inputs / 2 Audio outputs

1.2.3 On Screen Display and RTC (Real time clock) Function

1.2.4 Multiplexing

- I Support from 4 channels up to 7/ 9 channels.
- I 9 channels can record or display real-time recorded images.
- I 9 channels loop back terminal.

1.2.5 Resolution

Screen Modes	Resolution
Full screen	704(H) x 468(V) <NTSC> / 704(H) x 564(V) <PAL>
4 channels	352(H) x 234(V) <NTSC> / 352(H) x 282(V) <PAL>
9 channels	224(H) x 156(V) <NTSC> / 224(H) x 188(V) <PAL>

1.2.6 Independent main and call monitor outputs allow simultaneous multi-camera or full screen viewing.

1.2.7 Multi Screen Display Mode

- I Below display modes are selectable while surveillance & DMR play back:

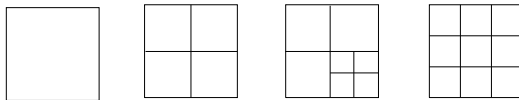

Full Screen Quad 7 CH 9 CH

1.2.8 Picture-In-Picture (PIP) is available in live and DMR playback modes, Zoom capability up to 2 X 2 in live and DMR playback modes

1.2.9 16 channels are swappable and each channel has independent title generator (up to 6 characters).

1.2.10 Motion detection using 15x12 target (NTSC) 15x14 target (PAL) motion detection grids for each video channel.

1.2.11 Video Quality Adjustable on Each Channel

1.2.12 Alarm Input Function & Output Function

1.2.13 16 channels alarm input, ALARM display and one alarm output.

- I Video loss detected on each channel can record 160 events.

1.2.14 Power-loss memory function: set up parameter will remain, in case of power failure.

1.2.15 Call Monitor: Switch Display

1.2.16 Support 1 Removable HDD, IDE Type (over 250GB)

1.2.17 Timer: Schedule recording

1.2.18 Display refresh rate up to 72 IPS (60 IPS for PAL)

1.2.19 Record refresh rate up to 25 IPS (18 IPS for PAL)

1.2.20 Quick Multiple Search by date/time, alarm, full list

1.2.21 Fast and slow playback in multiple speeds.

1.2.22 Security password protection

1.2.23 RS-232, RS-485 communication protocol

1.3 Specifications

Video format	NTSC/EIA or PAL/CCIR
Hard disk storage	IDE type, UDMA 66, 1 removable HDDs supported over 250GB
Record mode	Manual / Alarm / Timer / Motion
Camera Input Signal	Composite video signal 1 Vp-p 75Ω BNC, 16 channels
Camera Loop Back	Composite video signal 1 Vp-p 75Ω BNC, 16 channels
Main Monitor Output	Composite video signal 1 Vp-p 75Ω BNC
Call Monitor Output	Composite video signal 1 Vp-p 75Ω BNC
Audio input	4 audio inputs, (RCA)
Audio output	2 audio outputs, (RCA)
Motion Detect Area	15 * 12 targets per camera (NTSC) / 15 * 14 targets per camera (PAL)
Motion Detect Sensitivity	256 Levels
Video Loss Detection	Yes
Refresh Rate	72 images/sec. for NTSC / 60 images/sec. for PAL
Recording Rate	25 images/sec. for NTSC / 18 images/sec. for PAL
Dwell Time	Programmable (1~10 Sec)
Picture in Picture	Yes (Movable)
Key Lock	Yes
Picture Zoom	2*2 (Movable)
Camera Title	6 letters
Video Adjustable	Color/ Contrast/ Brightness Adjustable
Alarm Input	TTL input, Hi (5V), Low (GND)
Alarm Output	COM,/N.O/N.C.
Remote Control	RS-232 or RS-485
Time Display Format	YY/MM/DD, DD/MM/YY, MM/DD/YY, OFF
Power Source	AC100~240V ± 10% switching adaptor
Power Consumption	<27W
Operation Temperature	10 ~ 40°C
RS-232C / RS-485 (bps)	115200 · 57600 · 19200 · 9600 · 4800 · 3600 · 2400 · 1200
Dimension (mm)	432(W) x 110(H) x 325(D)
Net Weight	5.2 kgs

Specifications are subject to change without notice.

2. Installation

2.1 Package contents

The package contents the following items.

- I Digital Multiplex Recorder
- I HDD cartridge
- I Key for cartridge (Inside of HDD cartridge)
- I Power cord
- I User manual
- I Rack mounting kit (Optional)

2.2 Connection

2.2.1 Connect with cameras

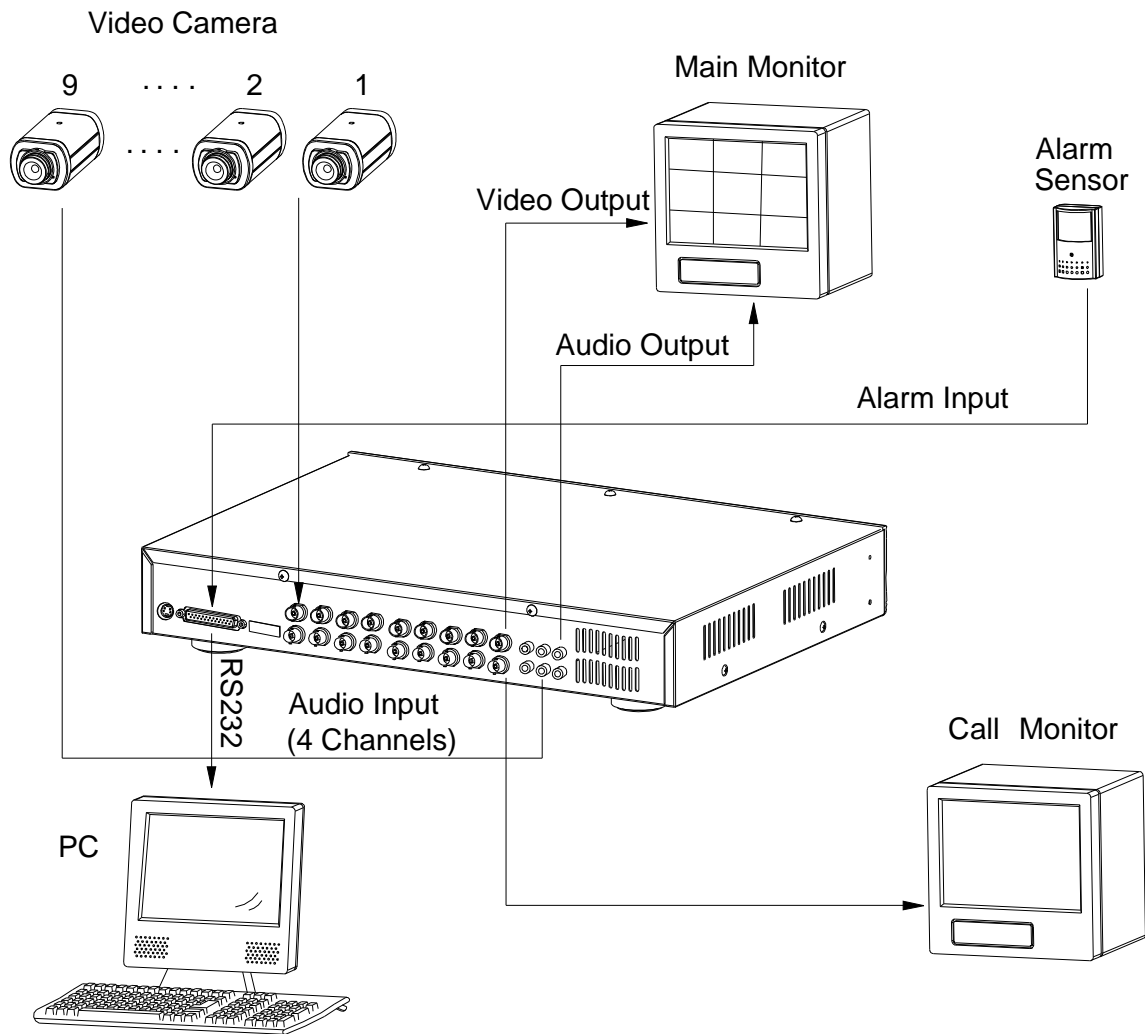

2.3 Rack mount installation

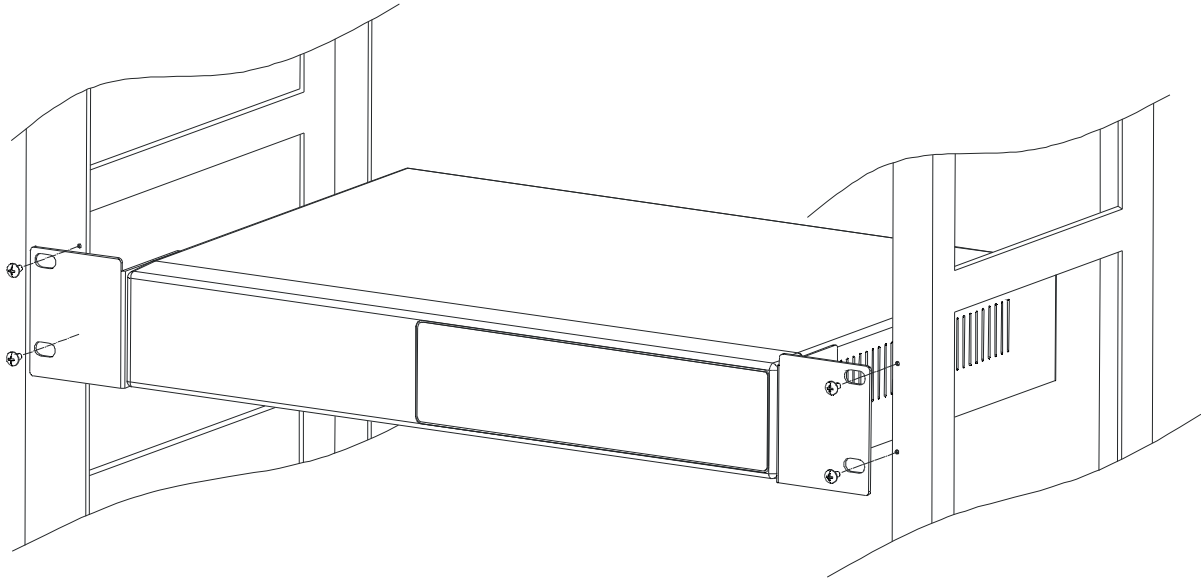

Front Angle with Rock Mount

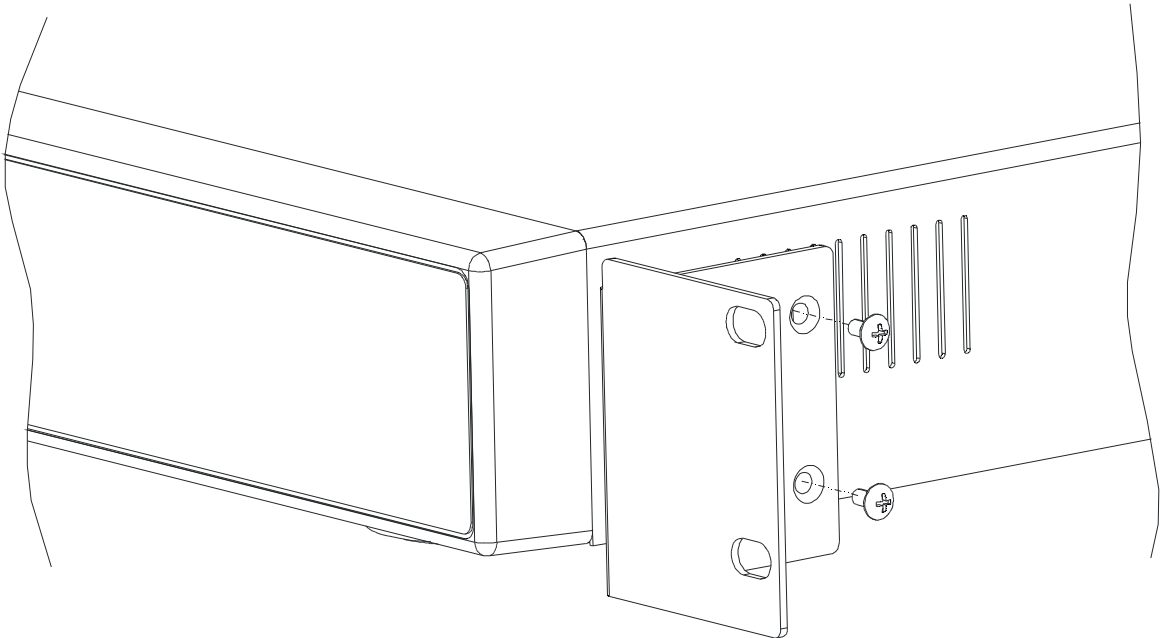

Side View with Rack Mount

2.4 RS232 Remote Protocol

You can use the PC keyboard to simulate DMR keypad.

DATA: REMOTE PROTOCOL using 8 bit data , 1 start bit , 1stop bit

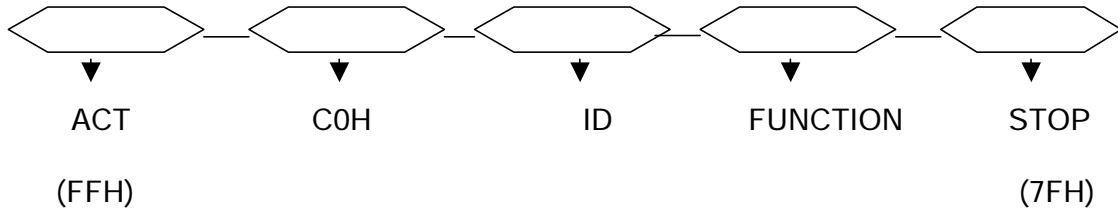

3. Configuration

3.1 Install HDD

3.1.1 Installing Hard Drive into Cartridge

- 3.1.1.1. Please find the Key in the Cartridge.
- 3.1.1.2. Push the front cover of the HDD cartridge and use the miniature key provided and insert into the key hole, turning the key counter-clockwise.
- 3.1.1.3. Pull the handle outwards to remove the carrier body away from the cartridge frame.
- 3.1.1.4. Push the open button to slide the top cover backwards and remove.
- 3.1.1.5. Insert the DC power cable and IDE cable on the HDD.
- 3.1.1.6. Position the HDD into carrier body and secure the HDD with the four 6#-32 screws provided.
- 3.1.1.7. Slide the top cover back to the carrier body by sliding it forward to secure.
- 3.1.1.8. Slide the carrier body back into the cartridge frame.

3.1.2 Function Settings and Operation

3.1.2.1 Power Indicator and HDD Access indicator

When power is on, the indicator will display the following message :

Item	Indicator
Power Indicator	Green LED
HDD Access Indicator	Yellow LED

3.1.3 Key lock

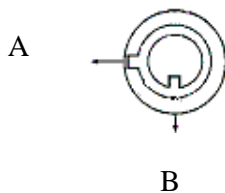

Status	Power status	Security status
Segment		
A	ON	Locked (Irremovable)
B	OFF	Unlocked (Removable)

You must turn key lock to “A” position before powering on the unit. Otherwise HDD will not operate properly.

3.1.4 The Record Time is different based on Record Speed and Record Quality.

Please refer to following table.

NTSC SYSTEM

IPS		25A	15	8	4	2	1
Record Quality	Best	24hr	48hr	90hr	180hr	360hr	720hr
	High	30hr	60hr	112.5hr	225hr	450hr	900hr
	Normal	48hr	96hr	180hr	360hr	720hr	1440hr
	Basic	80hr	160hr	300hr	600hr	1200hr	2400hr
HDD Type		120GB					

PAL SYSTEM

IPS		18A	12	6	3	2	1
Record Quality	Best	24hr	50hr	101hr	203hr	304hr	608hr
	High	30hr	63hr	127hr	253hr	380hr	760hr
	Normal	49hr	101hr	203hr	405hr	608hr	1220hr
	Basic	81hr	168hr	338hr	675hr	1013hr	2025hr
HDD Type		120GB					

**Note: Above data is from actual test data obtained from recording normal TV program.
(Reference only)**

3.2 Front panel keypad

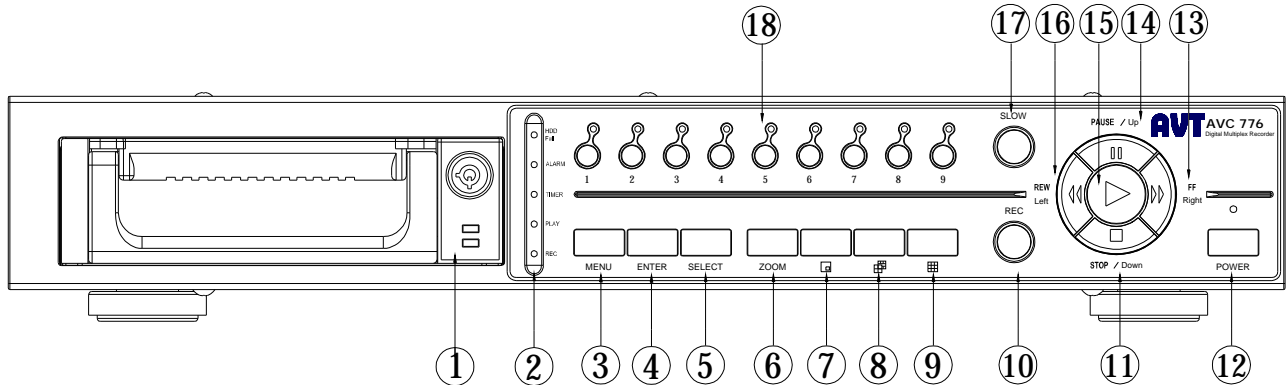

Please follow the instructions below to operate this unit.

1. Install HDD

This device equips with a removable hard disk drive tray. Before turning on this device, you must install hard disk drive (not including in standard package), and make it ready to operate. (If two HDDs are set up, one should be selected as “ Master” and the other should be selected as “ Slave”. Otherwise, please set two HDDs to Cable Select.)

2. LED Light : Under following condition, the LED Light is ON.

- (1) HDD : HDD is activated
- (2) HDD Full : HDD is full
- (3) ALARM : When Alarm Enable : Yes (when alarm is triggered, the led is flashing)
- (4) TIMER : When Timer Enable : Yes
- (5) PLAY : Play operation
- (6) REC : Recording operation

3. MENU : Press **MENU** to enter main menu operation mode, and press administrator password (default:0000) to access main menu.

4. ENTER : Press **ENTER** for confirmation.

5. SELECT : Press the Select to select appointed camera (1~16) to display on full screen mode.

6. ZOOM : Press **ZOOM** button to enlarge the main monitor picture display.

7. : Picture in Picture. Press PIP button to enter PIP display screen.

8. : 4, 7 channels display mode

9. : 9 channels display mode

10. REC : Press **REC** to start recording.

11. STOP / Down :

STOP : Under DMR Record/Play mode, it can play video stop recording.

Down : Under setup mode , it can work as **Down** button.

12. POWER : To power on, press power button.

To power off, press power button again.

13. FF / Right :

FF : Under DMR play mode, it can play video forward at high speed, and press **FF** again to adjust speed from 1, 2, 4, 8, 16, 32 times.

Right : Under setup mode , it can work as **Right** button.

14. PAUSE / Up :

Pause : Under DMR play mode, it can play video pause.

Up : Under setup mode , it can work as **Up** button.

15. PLAY : Press **PLAY** to play recorded video.

16. REW / Left :

REW : Under DMR play mode, it can play video backward at high speed, and press REW again to adjust speed from 1, 2, 4, 8, 16, 32 times

Left : Under setup mode , it can work as **Left** button.

17. SLOW : To press **SLOW** to slow down speed of play mode.

18. CAMERA (1-16) : Press the **Camera Select (1-16)** to select appointed camera

PS 1 . After 60 seconds suspended operation, the function setup will be turned up automatically.

2. When setting the same channel, the duplicate pictures will be frozen.

3.3 Back panel connection

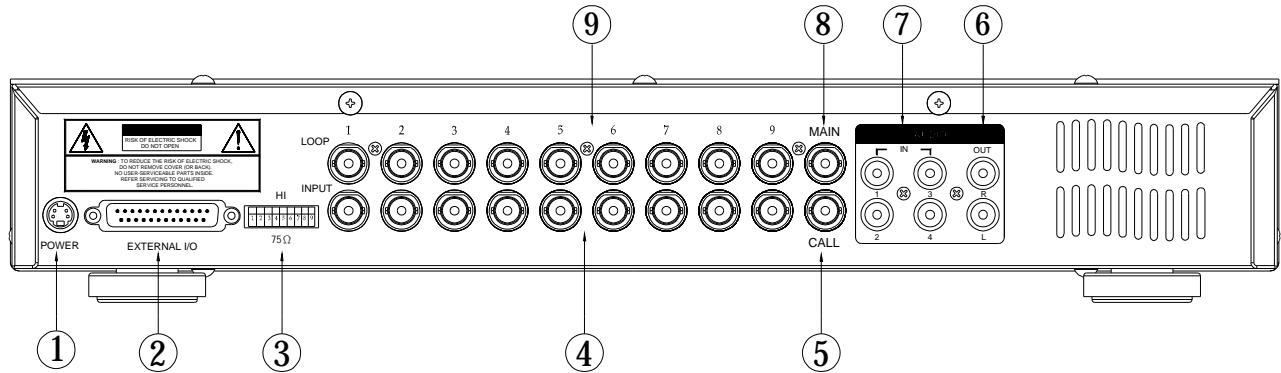

1. Power input

Please use the provided adaptor.

2. External I/O

Controlled remotely by an external device or control system.

Alarm input, external I/O explanation.

3. 75 Ω / HI

When using Loop function, please switch to **HI** or set up to **75**.

4. VIDEO INPUT (1-16)

Connect to video source, such as camera.

5. CALL

Connect to CALL monitor. Show the Switch Display.

6. AUDIO OUT (R/L)

Connect to monitor or speaker.

* **IPS should be set to 25A (for NTSC) or 18A (for PAL)**

7. AUDIO IN (1-4)

Connect to audio source, such as microphone.

* **IPS should be set to 25A (for NTSC) or 18A (for PAL)**

8. MAIN

Connect to Main monitor

9. Loop

Connect video signal between Input port and Loop port to make a loop.

3.4 External I/O

25 pin com port

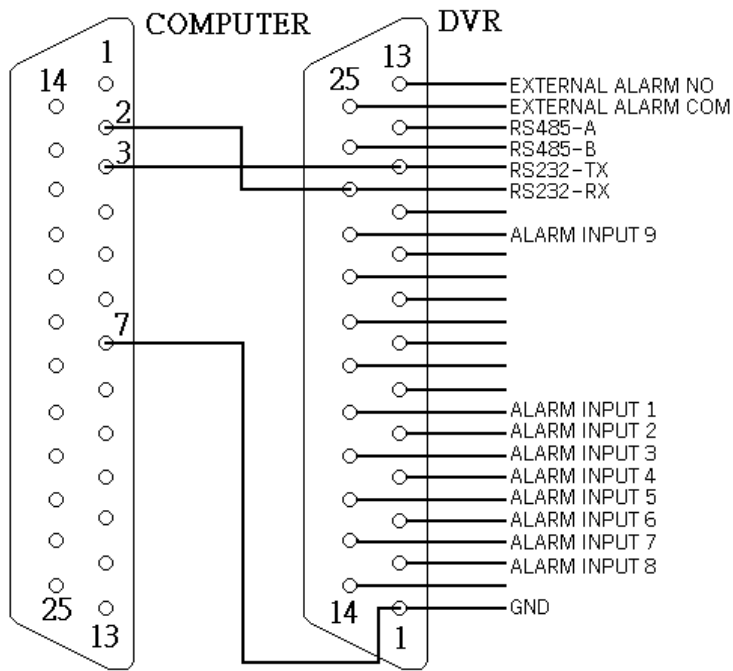

9 pin com port

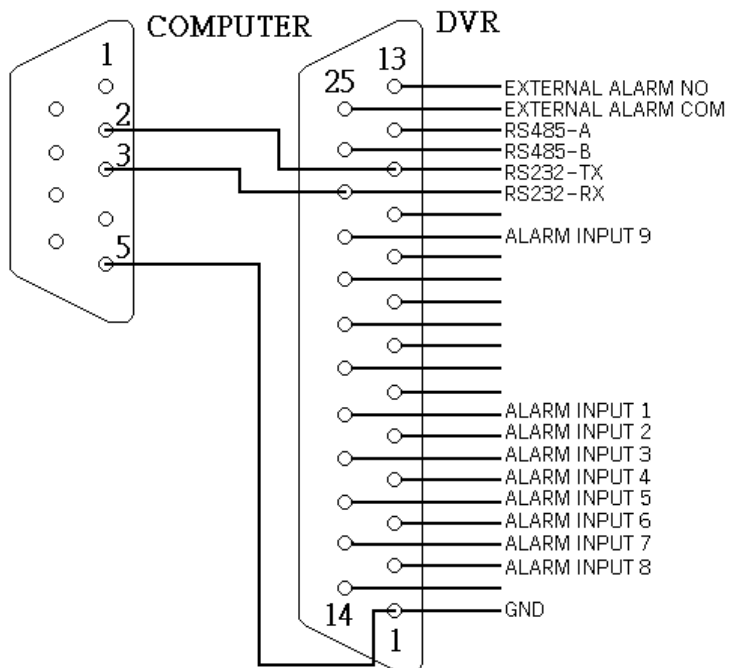

PIN 1. GND

GROUND

PIN 2. ALARM INPUT 8

To connect wire from **ALARM INPUT 8 (PIN 2)** to **GND (PIN 1)** connector, DMR will start recording and buzzer will be on.

When Menu/ Camera/ Alarm is set up to “Low” : When alarm input signal is “ Low ”, the unit starts to record and buzzer.

When Menu/ Camera/ Alarm is set up to “High” : When alarm input signal is “ High ”, the unit starts to record and buzzer.

PIN 3. ALARM INPUT 6

To connect wire from **ALARM INPUT 6 (PIN 3)** to **GND (PIN 1)** connector, DMR will start recording and buzzer will be on.

When Menu/ Camera/ Alarm is set up to “Low” : When alarm input signal is “ Low ”, the unit starts to record and buzzer.

When Menu/ Camera/ Alarm is set up to “High” : When alarm input signal is “ High ”, the unit starts to record and buzzer.

PIN 4. ALARM INPUT 4

To connect wire from **ALARM INPUT 4 (PIN 4)** to **GND (PIN 1)** connector, DMR will start recording and buzzer will be on

When Menu/ Camera/ Alarm is set up to “Low” : When alarm input signal is “ Low ”, the unit starts to record and buzzer.

When Menu/ Camera/ Alarm is set up to “High” : When alarm input signal is “ High ”, the unit starts to record and buzzer.

PIN 5. ALARM INPUT 2

To connect wire from **ALARM INPUT 2 (PIN 5)** to **GND (PIN 1)** connector, DMR will start recording and buzzer will be on.

When Menu/ Camera/ Alarm is set up to “Low” : When alarm input signal is “ Low ”, the unit starts to record and buzzer.

When Menu/ Camera/ Alarm is set up to “High” : When alarm input signal is “ High ”, the unit starts to record and buzzer.

PIN 6. PIN OFF

PIN 7. PIN OFF

PIN 8. PIN OFF

PIN 9. PIN OFF

PIN 10. PIN OFF

PIN 11. RS232-TX

DMR can be controlled remotely by an external device or control system, such as a control keyboard, using RS-232 serial communications signals.

PIN 12. RS485-A

DMR can be controlled remotely by an external device or control system, such as a control keyboard, using RS485 serial communications signals.

PIN 13. EXTERNAL ALARM NO

Under normal operation COM disconnect with NO. But when Alarm triggered, COM connect with NO.

PIN 14. PIN OFF

PIN 15. ALARM INPUT 7

To connect wire from **ALARM INPUT 7 (PIN 15)** to **GND (PIN 1)** connector, DMR will start recording and buzzer will be on.

When Menu/ Camera/ Alarm is set up to “Low” : When alarm input signal is “ Low ”, the unit starts to record and buzzer.

When Menu/ Camera/ Alarm is set up to “High” : When alarm input signal is “ High ”, the unit starts to record and buzzer.

PIN 16. ALARM INPUT 5

To connect wire from **ALARM INPUT 5 (PIN 16)** to **GND (PIN 1)** connector, DMR will start recording and buzzer will be on.

When Menu/ Camera/ Alarm is set up to “Low” : When alarm input signal is “ Low ”, the unit starts to record and buzzer.

When Menu/ Camera/ Alarm is set up to “High” : When alarm input signal is “ High ”, the unit starts to record and buzzer.

PIN 17. ALARM INPUT 3

To connect wire from **ALARM INPUT 3 (PIN 17)** to **GND (PIN 1)** connector, DMR will start recording and buzzer will be on.

When Menu/ Camera/ Alarm is set up to “Low” : When alarm input signal is “ Low ”, the unit starts to record and buzzer.

When Menu/ Camera/ Alarm is set up to “High” : When alarm input signal is “ High ”, the unit starts to record and buzzer.

PIN 18. ALARM INPUT 1

To connect wire from **ALARM INPUT 1 (PIN 18)** to **GND (PIN 1)** connector, DMR will start recording and buzzer will be on.

When Menu/ Camera/ Alarm is set up to “Low” : When alarm input signal is “ Low ” , the unit starts to record and buzzer.

When Menu/ Camera/ Alarm is set up to “High” : When alarm input signal is “ High ” , the unit starts to record and buzzer.

PIN 19. PIN OFF

PIN 20. PIN OFF

PIN 21. PIN OFF

PIN 22. ALARM INPUT 9

To connect wire from **ALARM INPUT 9 (PIN 22)** to **GND (PIN 1)** connector, DMR will start recording and buzzer will be on.

When Menu/ Camera/ Alarm is set up to “Low” : When alarm input signal is “ Low ” , the unit starts to record and buzzer.

When Menu/ Camera/ Alarm is set up to “High” : When alarm input signal is “ High ” , the unit starts to record and buzzer.

PIN 23. RS232-RX

DMR can be controlled remotely by an external device or control system, such as a control keyboard, using RS-232 serial communications signals.

PIN 24. RS485-B

DMR can be controlled remotely by an external device or control system, such as a control keyboard, using RS485 serial communications signals.

PIN 25. EXTERNAL ALARM COM

Under normal operation COM disconnect with NO. But when alarm triggered, COM connect with NO.

3.4 Menu setup

Press **"MENU"** to enter main menu. You will need to enter password to access main menu. To press **"Right"** **"Left"** to move digit, and Press **"Up"** **"Down"** to select number. Press **"ENTER"** button to confirm password.

Ex.: Password : 0000 (Default : 0000)



After keying in correct password, confirm by pressing **"ENTER"** button, screen will show following options.

SEARCH ----- Find recorded list
TIMER ----- Scheduling Record
RECORD----- Record Mode Setup
CAMERA ----- Camera Channel Setup
SYSTEM ----- System Setup
EVENT ----- Event List

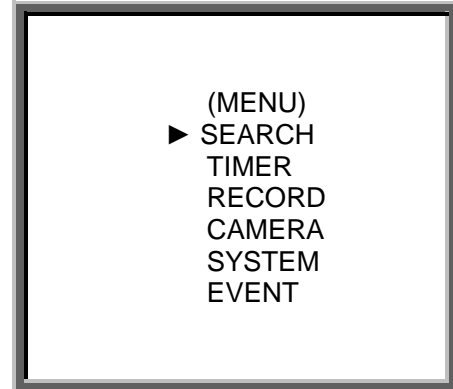

**For the unit can be operated properly, we start to introduce from System setup*

3.5 System setup

Press **"MENU"** to enter main menu. You will need to enter password to access main menu. Press **"Right"** **"Left"** to move digit, and Press **"Up"** **"Down"** to select number. Press **"ENTER"** button to confirm password.

Ex.: PASSWORD : 0000 (Default : 0000)



After keying in correct password, and confirm by pressing **"ENTER"** button, screen will show following options.

SEARCH ----- Find recorded list
TIMER ----- Scheduling Record
RECORD----- Record Mode Setup
CAMERA ----- Camera Channel Setup
SYSTEM ----- System Setup
EVENT ----- Event List

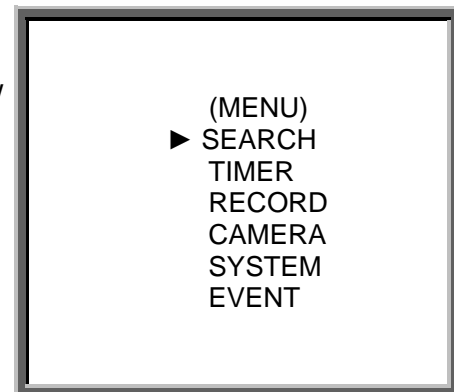

Press "Up" "Down" to choose **SYSTEM** setup

SEARCH
TIMER
RECORD
CAMERA
▶ SYSTEM
EVENT



Press "ENTER" to confirm **SYSTEM** setup, and the screen will show following options.

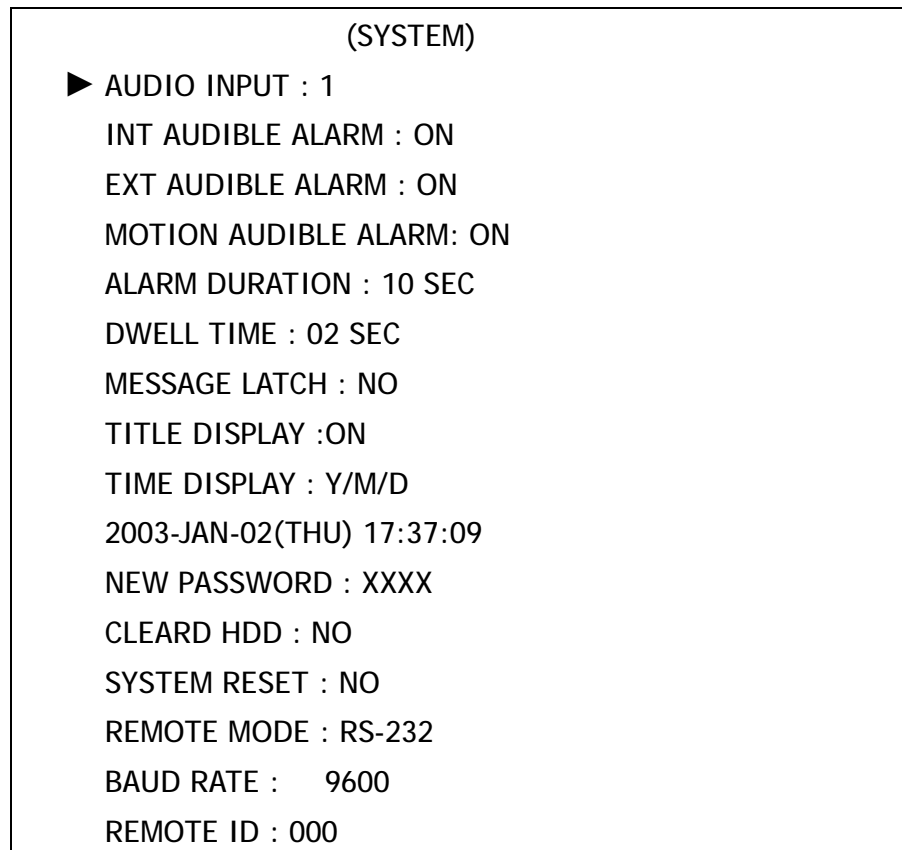

3.5.1 AUDIO INPUT setup:

This device allows user to set the AUDIO INPUT. User can choose one of 4 channels to record.

3.5.1.1 Press "Up" "Down" to choose AUDIO INPUT :

3.5.1.2 Press "ENTER" button to confirm AUDIO INPUT

3.5.1.3 Press "Up" "Down" to choose the AUDIO INPUT : 1~4

3.5.1.4 Press "MENU" to exit and confirm current operation.

3.5.1.5 Press "MENU" again to exit and close **SYSTEM** setup mode.

3.5.2 INT AUDIBLE ALARM setup:

This device allows user to set the INTERNAL AUDIBLE ALARM. Alarm will be triggered by event occurrence when the setting is ON.

3.5.2.1 Press " **Up**" or " **Down**" to choose INT AUDIBLE ALARM

3.5.2.2 Press " **ENTER**" button to confirm INT AUDIBLE ALARM

3.5.2.3 Press " **Up**" or " **Down**" to choose the INT AUDIBLE ALARM : ON/OFF

ON: Internal Buzzer ON

OFF: Internal Buzzer OFF

3.5.2.4 Press " **MENU**" to exit and confirm current operation.

3.5.2.5 Press " **MENU**" again to exit and close **SYSTEM** setup mode.

3.5.3 EXT AUDIBLE ALARM setup:

This device allows user to set the EXTERNAL AUDIBLE ALARM. Alarm will be triggered by event occurrence when the setting is ON.

3.5.3.1 Press " **Up**" or " **Down**" to choose EXT AUDIBLE ALARM

3.5.3.2 Press " **ENTER**" button to confirm EXT AUDIBLE ALARM

3.5.3.3 Press " **Up**" or " **Down**" to choose the EXT AUDIBLE ALARM: ON/OFF

ON: External Buzzer ON

OFF: External Buzzer OFF

3.5.3.4 Press " **MENU**" to exit and confirm current operation.

3.5.3.5 Press " **MENU**" again to exit and close **SYSTEM** setup mode.

3.5.4 MOTION AUDIBLE ALARM

To set the MOTION AUDIBLE ALARM. It will be triggered by motion detection occurrence when the setting is ON.

3.5.5 ALARM DURATION Setup option:

This device allows user to set the ALARM DURATION. Reaction time was determined by how long the alarm mode responded to a buzzer.

3.5.5.1 Press " **Up**" or " **Down**" to choose ALARM DURATION setup.

3.5.5.2 Press " **ENTER**" to confirm ALARM DURATION setup.

3.5.5.3 Press " **Up**" or " **Down**" to choose ALARM DURATION setup

10 SEC, 15 SEC, 20 SEC, 30 SEC, 1MIN, 2MIN, 3 MIN, 5 MIN, 10 MIN, 15 MIN, 30 MIN, ALWAYS.

3.5.5.4 Press " **MENU**" to exit and confirm current operation.

3.5.5.5 Press " **MENU**" again to exit and close **SYSTEM** setup mode.

3.5.6 DWELL TIME setup

This device allows user to set the DWELL TIME. DWELL TIME is the lasting time that each channel sequentially shown on monitor.

3.5.6.1 Press " **Up** " or " **Down** " to choose DWELL TIME setup.

3.5.6.2 Press " **ENTER** " to confirm DWELL TIME setup.

3.5.6.3 Press " **Up** " or " **Down** " to choose DWELL TIME setup.

01~10 SEC.

3.5.6.4 Press " **MENU** " to exit and confirm current operation.

3.5.6.5 Press " **MENU** " again to exit and close **SYSTEM** setup mode.

3.5.7 MESSAGE LATCH setup

This device allows user to decide the  External Alarm graph  video loss graph showed on monitor or not.

3.5.7.1 Press " **Up** " or " **Down** " to choose MESSAGE LATCH setup

3.5.7.2 Press " **ENTER** " button to confirm MESSAGE LATCH setup

3.6.7.3 Press " **Up** " or " **Down** " to choose the MESSAGE LATCH : ON/OFF

ON : Message latch ON

OFF : Message latch OFF

3.6.7.4 Press " **MENU** " to exit and confirm current operation.

3.6.7.5 Press " **MENU** " again to exit and close **SYSTEM** setup mode.

3.5.8 TITLE DISPLAY setup

This device allows user to set the title shown on monitor or not.

3.5.8.1 Press " **Up** " or " **Down** " to choose TITLE DISPLAY setup

3.5.8.2 Press " **ENTER** " button to confirm TITLE DISPLAY setup

3.5.8.3 Press " **Up** " or " **Down** " to choose TITLE DISPLAY : ON/OFF

ON : Title Display ON

OFF : Title Display OFF

3.5.8.4 Press " **MENU** " to exit and confirm current operation.

3.5.8.5 Press " **MENU** " again to exit and close **SYSTEM** setup mode.

3.5.9 TIME DISPLAY format setup

This device allows user to set the time format on monitor.

3.5.9.1 Press " **Up** " or " **Down** " to choose TIME DISPLAY setup.

3.5.9.2 Press " **ENTER** " to confirm TIME DISPLAY setup.

3.5.9.3 Press" **Up** " or " **Down** " to choose TIME DISPLAY setup.

OFF, Y/M/D, M/D/Y, D/M/Y.

3.5.9.4 Press " **MENU** " to exit and confirm current operation.

3.5.9.5 Press " **MENU** " again to exit and close **SYSTEM** setup mode.

3.5.10 TIME setup:

This device allows user to set time on monitor.

3.5.10.1 Press " **Up** " or " **Down** " to choose date display

3.5.10.2 Press " **ENTER** " to confirm date display format.

3.5.10.3 Press " **Up** " or " **Down** " to choose the correct Date & Time, and press press
" **Right** " or " **Left** " to move digit location.

3.5.10.4 Press " **MENU** " to exit and confirm current operation.

3.5.10.5 Press " **MENU** " again to exit and close **SYSTEM** setup mode.

3.5.11 NEW PASSWORD : XXXX setup: (Default password : 0000)

This device allows user to set the new password.

3.5.11.1 Press " **Up** " or " **Down** " to choose NEW PASSWORD : XXXX setup.

3.5.11.2 Press " **ENTER** " to confirm NEW PASSWORD : XXXX setup.

3.5.11.3 Press " **Up** " or " **Down** " to choose number, and press" **Right** " or " **Left** " to
move digit location.

3.5.11.4 Press " **MENU** " to exit and confirm current operation.

3.5.11.5 Press " **MENU** " again to exit and close **SYSTEM** setup mode.

3.5.12 CLEAR HDD setup

This device allows user to have the HDD cleared.

3.5.12.1 Press " **Up** " or " **Down** " to choose CLEAR HDD setup.

3.5.12.2 Press " **ENTER** " to confirm CLEAR HDD setup.

3.5.12.3 Press " **Up** " or " **Down** " to choose CLEAR HDD setup YES or NO.

YES: Confirm to clear HDD, and screen will show followings.

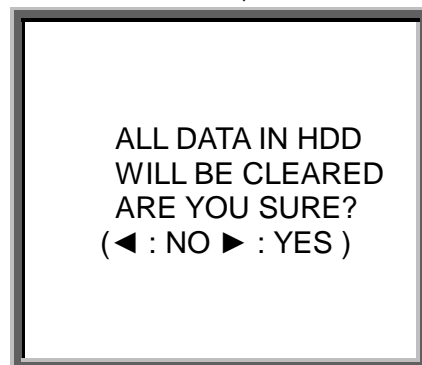

Press “▶” to clear HDD

NO: Confirm not to clear HDD.

3.5.12.4 Press ” **MENU** ” to exit and confirm current operation.

3.5.12.5 Press ” **MENU** ” again to exit and close **SYSTEM** setup mode.

3.5.13 SYSTEM RESET setup

This device allows user to reset the system.

3.5.13.1 Press ” **Up** ” or “ **Down** ” to choose SYSTEM RESET setup.

3.5.13.2 Press ” **ENTER** ” to confirm SYSTEM RESET setup.

3.5.13.3 Press ” ” **Up** ” or “ **Down** ” to choose SYSTEM RESET Yes or No

YES: To confirm System Reset (load default system reset)

NO: Confirm not to System Reset

3.5.13.4 Press ” **MENU** ” to exit and confirm current operation.

3.5.13.5 Press ” **MENU** ” again to exit and close **SYSTEM** setup mode.

3.5.14 REMOTE MODE setup

This device allows user to set the remote mode.

3.5.14.1 Press ” **Up** ” or “ **Down** ” to choose REMOTE MODE setup

3.5.14.2 Press ” **ENTER** ” to confirm REMOTE MODE setup

3.5.14.3 Press ” **Up** ” or “ **Down** ” to choose Interface for REMOTE MODE setup

RS-232: Use RS-232 interface

RS-485: Use RS-485 interface

3.5.14.4 Press ” **MENU** ” to exit and confirm current operation.

3.5.14.5 Press ” **MENU** ” again to exit and close **SYSTEM** setup mode.

3.5.15 Remote protocol Transmitting Baud Rate setup

This device allows user to set the remote protocol transmitting baud rate.

3.5.15.1 Press ” **Up** ” or “ **Down** ” to choose Baud Rate setup.

3.5.15.2 Press ” **ENTER** ” to confirm

3.5.15.3 Press ” **Up** ” or “ **Down** ” to choose BAUD RATE setup

115200 、 57600 、 19200 、 9600 、 4800 、 3600 、 2400 、 1200

3.5.15.4 Press ” **MENU** ” to exit and confirm current operation.

3.5.15.5 Press ” **MENU** ” again to exit and close **SYSTEM** setup mode.

3.5.16 Remote protocol ID setup:

This device allows user to control different DMR by setting RS232 remote protocol. ID number can be set from 000 to be 999.

3.5.16.1 Press "Up" or "Down" to choose ID setup.

3.5.16.2 Press "ENTER" to confirm ID setup

3.5.16.3 Press "Up" or "Down" to set numerical number, from 000 ~ 255

3.5.16.4 Press "MENU" to exit and confirm current operation.

3.5.16.5 Press "MENU" again to exit and close SYSTEM setup mode.

3.6 SEARCH setup

Press "MENU" to enter main menu. You will need to enter password to access main menu. Press "Right" or "Left" to move digit, and to press "Up" or "Down" to select number. Press "ENTER" button to confirm password.

Ex.: Password: 0000 (Default: 0000)



After keying in correct password, and confirm by pressing "ENTER" button, screen will show following options.

SEARCH ----- Find recorded list
TIMER ----- Scheduling Record
RECORD----- Record Mode Setup
CAMERA ----- Camera Channel Setup
SYSTEM ----- System Setup
EVENT ----- Event List

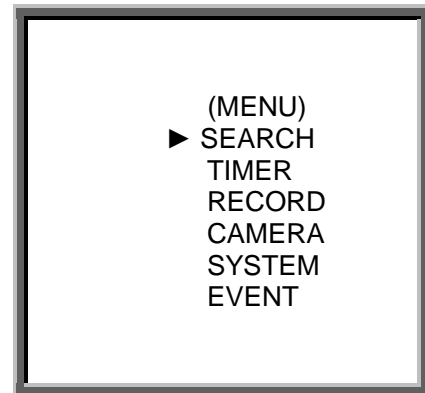

3.6.1 LAST RECORD for recorded video

Press "Up" or "Down" to choose LAST RECORD item. Following screen will be displayed. Press "ENTER" to confirm LAST RECORD.



3.6.2 FULL LIST for recorded video

Press " **Up** " or " **Down** " to choose Full List item. Following screen will be displayed.



Press " **ENTER** " to confirm Full List, and the following screen will be displayed.

Press " **Up** " or " **Down** " to choose wanted recorded event (There will be shown only 8 list in one page.), and press " **Right** " or " **Left** " to change the pages.

Press " **ENTER** " to Play selected recorded video

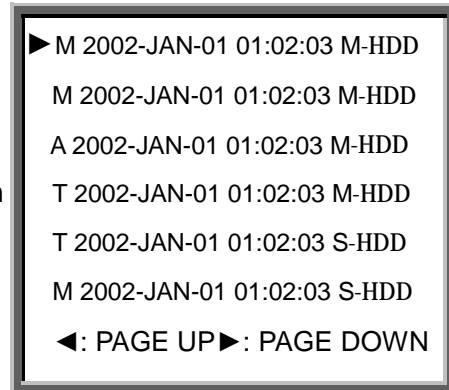

M : Manual Record time / A : Alarm Record time

T : Timer Record time

M-HDD : Storage in Master HDD

S-HDD : Storage in Slave HDD

3.6.3 ALARM LIST for recorded video

Press " **Up** " or " **Down** " to choose ALARM LIST. Following screen will be displayed.



Press “**ENTER**” to confirm FULL LIST, and the following screen will be displayed.
Press ” **Up** ” or “ **Down** ” to choose wanted recorded event (There will be shown only 8 list in one page.), and press “ **Left** ” or “ **Right** ” to change the pages.
Press “**ENTER**” to Play selected recorded video

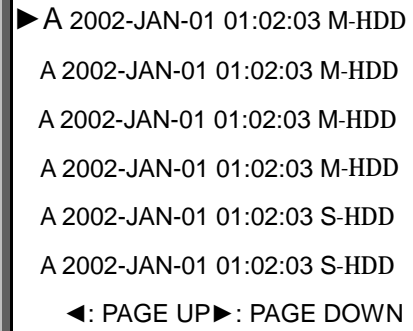

▶ A 2002-JAN-01 01:02:03 M-HDD
A 2002-JAN-01 01:02:03 M-HDD
A 2002-JAN-01 01:02:03 M-HDD
A 2002-JAN-01 01:02:03 M-HDD
A 2002-JAN-01 01:02:03 S-HDD
A 2002-JAN-01 01:02:03 S-HDD
◀: PAGE UP▶: PAGE DOWN

3.6.4 MOTION LIST for recorded video

Show a listing of all motion detection triggered.



LAST RECORD
FULL LIST
ALARM LIST
▶ MOTION LIST
TIME SEARCH

3.6.5 TIME SEARCH for recorded video

Press” **Up** ” or “ **Down** ” to choose Time Search item. Following screen will be displayed.



LAST RECORD
FULL LIST
ALARM LIST
MOTION LIST
▶ TIME SEARCH

Press “**ENTER**” to confirm Full List, and the screen will be as right displayed.
Press ” **Up** ” or “ **Down** ” to choose the wanted date & hour for recorded event , and press “ **Left** ” or “ **Right** ” to change the location.
Press “**ENTER**” to play select time recorded video. If there is no record in the database, the screen will display “ **NOT FOUND** ” .



PLAY TIME: 2002-JAN-01 18

3.7 **TIMER setup (Schedule Time-Lapse record mode setup)**

3.7.1 Enter TIMER setup

Press "**MENU**" to enter main menu. You will need to enter password to access main menu. To press " Left " or "Right " to move digit, and press " Up " or " Down " to select number. Press "**ENTER**" button to confirm password.

Ex.: PASSWORD : 0000 (Default : 0000)



After keying in correct password, and confirm by pressing "**ENTER**" button, following screen will be displayed. SEARCH ----- find recorded list

TIMER ----- scheduling Record
RECORD----- Record Mode Setup
CAMERA ----- Camera Channel Setup
SYSTEM ----- System Setup
EVENT ----- Event List

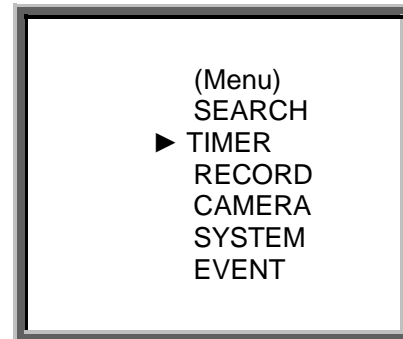

Select TIMER item, and press "**ENTER**" button to confirm TIMER Record setup mode. Following screen will be displayed.

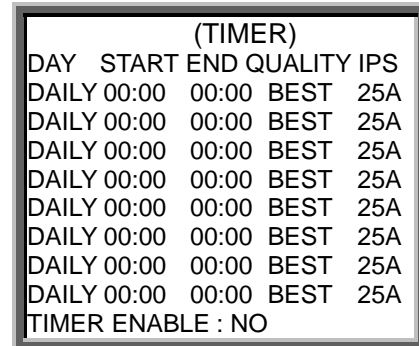

3.7.2 TIMER setup:

3.7.2.1 Press "**ENTER**" to confirm TIMER setup.

3.7.2.2 Press "**Up**" or "**Down**" to choose the Timer Record day

Daily : Everyday

MON : Monday

TUE : Tuesday

WED : Wednesday

THU : Thursday

FRI : Friday

SAT : Saturday

SUN : Sunday
MO-FR : Monday to Friday
SA-SU : Saturday & Sunday
JAN-01 : Special Date
OFF : Not activated

3.7.2.3 Press “ **Left** ” or “ **Right** ” move to START record time 00:00 (HH:MM)
Press ” **Up** ” or “ **Down** ” to change START record time numerical digit

3.7.2.4 Press “ **Left** ” or “ **Right** ” move to END record time 00:00 (HH:MM)
Press ” **Up** ” or “ **Down** ” to change END record Time numerical digit

3.7.2.5 Press “ **Left** ” or “ **Right** ” move to QUALITY
Press” **Up** ” or “ **Down** ” to choose options of
BEST, HIGH, NORMAL, BASIC

3.7.2.6 Press “ **Left** ” or “ **Right** ” move to Record IPS (Images Per Second)
Press” **Up** ” or “ **Down** ” to choose options of
NTSC – 25A 、 15 、 8 、 4 、 2 、 1
PAL – 18A 、 12 、 6 、 3 、 2 、 1

3.7.2.7 Press ” **MENU** ” to confirm current operation, and enter to next Timer Record
setup.

3.7.2.8 Press “ **Left** ” or “ **Right** ” move location to Timer Enable : Yes or No setup
YES : To confirm Timer Enable : Scheduling Timer Record function
NO : To confirm no Timer Enable : No Scheduling Timer Record function

3.7.2.9 Press ” **MENU** ” to exit and confirm current operation.

3.7.2.10 Press again ” **MENU** ” to exit and close TIMER setup mode.

3.8 RECORD setup

3.8.1 To Enter “ Record “ setup

Press ” **MENU** ” to enter main menu. You will need to enter password to access main menu. To press “ **Left** ” or “ **Right** ” to move digit, and to press ” **Up** ” or “ **Down** ” to select number. To press ” **ENTER** ” button to confirm password.

Ex.: PASSWORD: 0000 (Default: 0000)

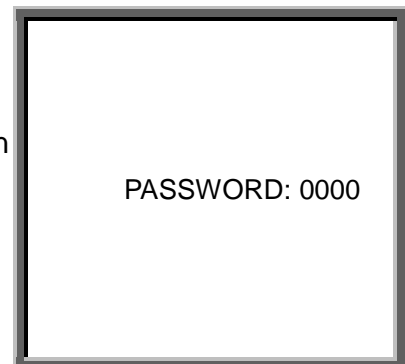

After keying in correct password, and confirm by pressing " **ENTER** " button, following screen will be displayed. SEARCH ----- find recorded list
TIMER ----- scheduling Record
RECORD----- Record Mode Setup
CAMERA ----- Camera Channel Setup
SYSTEM ----- System Setup
EVENT ----- Event List

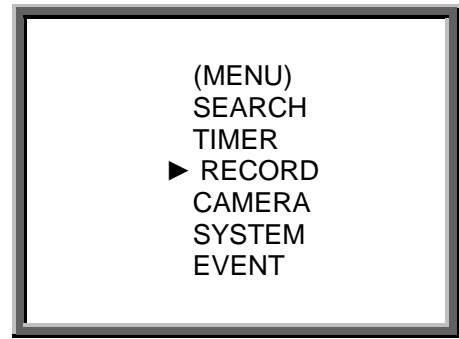

To choose Record item, and press " **ENTER** " to enter Record mode. Following screen will be displayed.



3.8.2 HDD OVERWRITE setup :

3.8.2.1 Press " **ENTER** " to confirm HDD OVERWRITE setup.

3.8.2.2 Press " **Up** " or " **Down** " to choose HDD OVERWRITE.

NO : When HDD full will stop recording

YES : When HDD full will overwrite the HDD recording

3.8.2.3 Press " **MENU** " to exit and confirm current operation.

3.8.2.4 Press again " **MENU** " to exit and close HDD OVERWRITE setup mode.

3.8.2.5 If the HDDs' capacity is only 5 GB left, it will buzz for 3 seconds; so as in 4 GB, 3 GB, 2 GB and 1GB. If the O/W Recording mode is on, it won't have the warning buzzer.

3.8.3 RECORD IPS setup:

3.8.3.1 Press " **ENTER** " to confirm RECORD IPS setup.

3.8.3.2 Press " **Up** " or " **Down** " to choose IPS record speed.

NTSC—25A、15、8、4、2、1

PAL—18A、12、6、3、2、1

3.8.3.3 Press " **MENU** " to exit and confirm current operation.

3.8.3.4 Press " **MENU** " again to exit and close RECORD IPS setup mode.

3.8.4 RECORD QUALITY setup

3.8.4.1 Press " **ENTER** " to confirm Record Quality setup.

3.8.4.2 Press " **Up** " or " **Down** " to choose Record Quality level.

BEST, HIGH, NORMAL, BASIC

3.8.4.3 Press " **MENU** " to exit and confirm current operation.

3.8.4.4 Press " **MENU** " again to exit and close RECORD QUALITY setup mode.

3.8.5 ALARM REC IPS setup

3.8.5.1 Press " **ENTER** " to confirm ALARM REC IPS setup.

3.8.5.2 Press " **Up** " or " **Down** " to choose ALARM REC IPS record speed.

NTSC—25A、15、8、4、2、1

PAL—18A、12、6、3、2、1

3.8.5.3 Press " **MENU** " to exit and confirm current operation.

3.8.5.4 Press again " **MENU** " to exit and close ALARM REC IPS setup mode.

3.8.6 ALARM REC QUALITY setup

3.8.6.1 Press " **ENTER** " to confirm ALARM REC QUALITY setup.

3.8.6.2 Press " **Up** " or " **Down** " to choose ALARM REC QUALITY level.

BEST, HIGH, NORMAL, BASIC

3.8.6.3 Press " **MENU** " to exit and confirm current operation.

3.8.6.4 Press again " **MENU** " to exit and close ALARM REC QUALITY setup mode.

3.8.7 MOTION TRIGGER RECORD

When you set up the MOTION DETECTION function:

1. Select "ON" to set up the motion trigger record: It can automatically switch from stand-by mode to Record Mode. The motion detection will change the scanning sequence and shows  and "D" on the monitor.

NOTE: The trigger recording time will depend on ALARM DURATION mode setting (Please refer to page.11 for ALARM DURATION) and it will record from the last trigger time. For example, when the alarm duration setting is 1 min, the time recording time is from 9:00:00 to 9:01:00. If the motion detection triggered again at 9:00:40, the triggered recording time will from 9:00:00 to 9:00:40 and 9:00:40 to 9:01:40. The total recording time is 00:01:40.

2. Select "OFF": The screen shows  the motion detection will change the scanning sequence while in record mode and shows "M" on the monitor.

3.9 CAMERA setup

Press "MENU" to enter main menu. You will need to enter password to access main menu. Press " Left " or " Right " to move digit, and to press " Up " or " Down " to select number. To press " ENTER " button to confirm password.

Ex.: Password : 0000 (Default : 0000)



After keying in correct password, and confirm by pressing " ENTER " button, Following screen will be displayed. SEARCH ----- find recorded list

TIMER ----- scheduling Record
 RECORD----- Record Mode Setup
 CAMERA ----- Camera Channel Setup
 SYSTEM ----- System Setup
 EVENT ----- Event List



CAMERA setup

	TITLE	DWELL				ALARM	RECORD
▶	---- 01	ON	5	5	5	LOW	EVENT
	---- 02	ON	5	5	5	LOW	EVENT
	---- 03	ON	5	5	5	LOW	EVENT
	---- 04	ON	5	5	5	LOW	EVENT
	---- 05	ON	5	5	5	LOW	EVENT
	---- 06	ON	5	5	5	LOW	EVENT
	---- 07	ON	5	5	5	LOW	EVENT
	---- 08	ON	5	5	5	LOW	EVENT
	---- 09	ON	5	5	5	LOW	EVENT

3.9.1 TITLE :It allows you to assign a title to each camera input. Initially each title is the camera's

number.

3.9.1.1 Press " **Up** " or " **Down** " : Select channel in the Channel setup

3.9.1.2 Press **ENTER**: Confirm the channel

3.9.1.3 Press " **Left** " or " **Right** " : Select the location of title (6 characters maximum)

3.9.1.4 Press " **Up** " or " **Down** " : Select the characters for display (**0~9, A~Z,-, :, (,),**)

3.9.1.5 Press " **MENU** " : Confirm and exit the title setting

3.9.1.6 Press " **MENU** " : Exit the Channel setup

3.9.2 DWELL: to set up auto switching channel

3.9.2.1 Press " **Up** " or " **Down** " : Select channel in the Channel setup

3.9.2.2 Press " **ENTER** " : Enter the channel setup

3.9.2.3 Press " **Left** " or " **Right** " : Select DWELL on the screen

3.9.2.4 Press " **Up** " or " **Down** " : Select ON/OFF on the screen

3.9.2.5 Press " **MENU** " : Confirm and exit the dwell setting

3.9.2.6 Press " **MENU** " : Exit the channel setup

3.9.3  (**Brightness**) /  (**Contrast**) /  (**Color**): video adjustment of each channel

3.9.3.1 Press " **Up** " or " **Down** " : Select channel in the Channel setup

3.9.3.2 Press " **ENTER** " Enter the channel setup

3.9.3.3 Press " **Left** " or " **Right** " : Select brightness/contrast/color on the screen

3.9.3.4 Press " **Up** " or " **Down** " : Set up **0~9** on the screen.

3.9.3.5 Press " **MENU** " : Confirm and exit the brightness/contrast/color setting.

3.9.3.6 Press " **MENU** " : Exit the channel setup

3.9.4 ALARM

3.9.4.1 Press " **Up** " or " **Down** " : Select channel in the Channel setup

3.9.4.2 Press " **ENTER** " Enter the channel setup

3.9.4.3 Press " **Left** " or " **Right** " : Select ALARM on the screen

3.9.4.4 Press " **Up** " or " **Down** " : Select LOW/OFF/HIGH for alarm polarity

3.9.4.5 Press " **MENU** " : Confirm and exit the alarm setting.

3.9.4.6 Press " **MENU** " : Exit the channel setup

3.9.5 RECORD

3.9.5.1 Press " **Up** " or " **Down** " : Select channel in the Channel setup

3.9.5.2 Press " **ENTER** " : Enter the channel setup

3.9.5.3 Press " **Left** " or " **Right** " : Select Record on the screen.

3.9.5.4 Press " **Up** " or " **Down** " : Select VCR record method as below (VCR will only record the channel which has been set up for **EVENT/ NORMAL/ OFF**)

EVENT : when alarm input is triggered, VCR will record alarming channel more frequently. For example : VCR normal record method is 1-2-3-4-5-.....-9. In Event mode, when CH01 is triggered, the record method will become 1-2-1-3-1-4-1-5-...-9.

NORMAL : when external alarm is on, VCR will record normally as set up.

OFF : DMR will not record

3.9.5 Press " **MENU** " : Confirm and exit the record setting

3.9.6 Press " **MENU** " : Exit the channel setup

3.10 **MOTION DETECTION setup**

3.10.1 Press " **MENU** " to enter the menu set up, then " **Down** " to **CAMERA** setup, Press " **ENTER** " twice to enter the Motion Detection Setup .

3.10.2 Each screen displays the current camera picture overlaid with the motion targets (as Figure 1). You can push the button " **Left** " or " **Right** ", " **Up** " or " **Down** " to adjust motion detection in **ON** or **OFF**.

3.10.3 The targets on each motion setup can be turned to ON or OFF individually by row. To set up targets, using the following front panel buttons:

3.10.3.1 Press " **ENTER** " to confirm the channel

3.10.3.2 Press " **ENTER** " to enter motion mode

3.10.3.3 ▲ **Up** -- moves the target cursor up one row at a time.

3.10.3.4 ▼ **Down** -- moves the target cursor down one row at a time.

3.10.3.5 ◀ **Left** -- moves the target cursor left one column at a time.

3.10.3.6 ▶ **Right** -- moves the target cursor right one column at a time.

3.10.3.7 Press " **ENTER** " to turn the target cursor ON

Press " **ENTER** " again to turn the target cursor OFF

3.10.3.8 **Camera Select (1-15)** — toggles the corresponding target on the cursor line ON or OFF. (Figure 1) There are only 15 targets in a row, therefore; only Camera Selected (1-15) can be operated.

3.10.3.9 **Zoom** – turns all targets in the current row ON or OFF. (Figure 1-2)

3.10.3.10 **PIP** – turns all targets on the screen ON or OFF. (Figure 1-3)

3.10.4 Press “ **SLOW** “ button to setup the Sensitivity list **up to 255**

Press “ **REC** “ button to setup the Sensitivity list **down to 000**

Sensitivity value is related to motion and brightness change.

Low value (as 001) means higher sensitivity on motion and brightness change.

High value (as 255) means lower sensitivity on motion and brightness change.

User can choose the suitable sensitivity value in different locations.

The default value is set on 032.

Note:

If Motion Detection is set, and to be activated, there will be 2 actions as followings:

1). Live video - the motion detected camera(s) will be scanned more frequently, if the Video set up for 16 cameras, the sequence to scan the cameras are from 1st, 2nd, 3rd... until 16th cameras, but if the motion is detected on Camera #1, the sequence to scan #1 camera will be more frequently. It will be scanning as 1st, 2nd, 1st, 3rd, 1st, 4th...1st, 9th.

The motion-detected camera will be scanned more frequently, which will be one after another camera been detected. If 2nd camera and 3rd camera both motion detection are activated, they will be scanning as 1st, 2nd, 3rd, 2nd, 2nd, 3rd, 3rd, 2nd, 3rd, 4th, 2nd, 3rd....3rd, 9th, 2nd, 3rd and vice versa.

2). Recorded Video - more frequently video will be recorded for the motion detected cameras, function same as Live video in the above mentioned.

Basically, the motion detection will show  while in live mode on monitor. When motion trigger record setting is ON, it can automatically switch from stand-by mode to activate Record Mode.

Figure 1 MOTION DETECTION SETUP

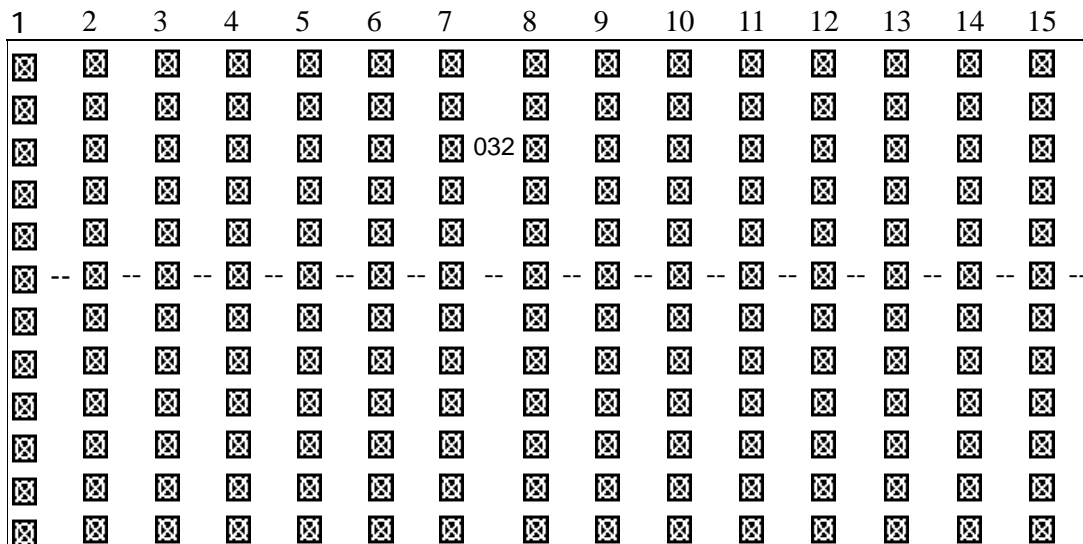

Figure 1-1 MOTION DETECTION SETUP – 1~16

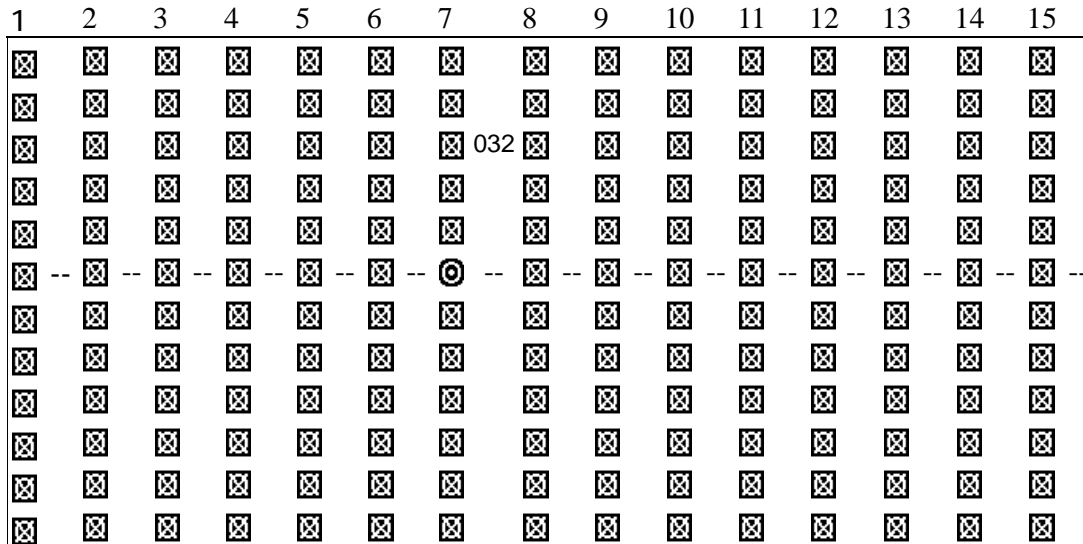

Figure 1-2 MOTION DETECTION SETUP – LINE

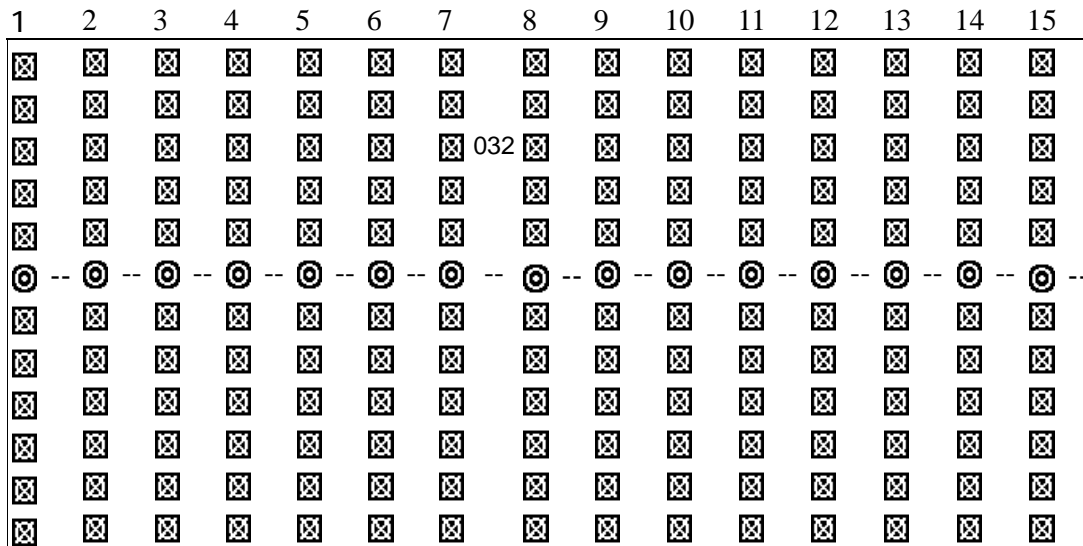
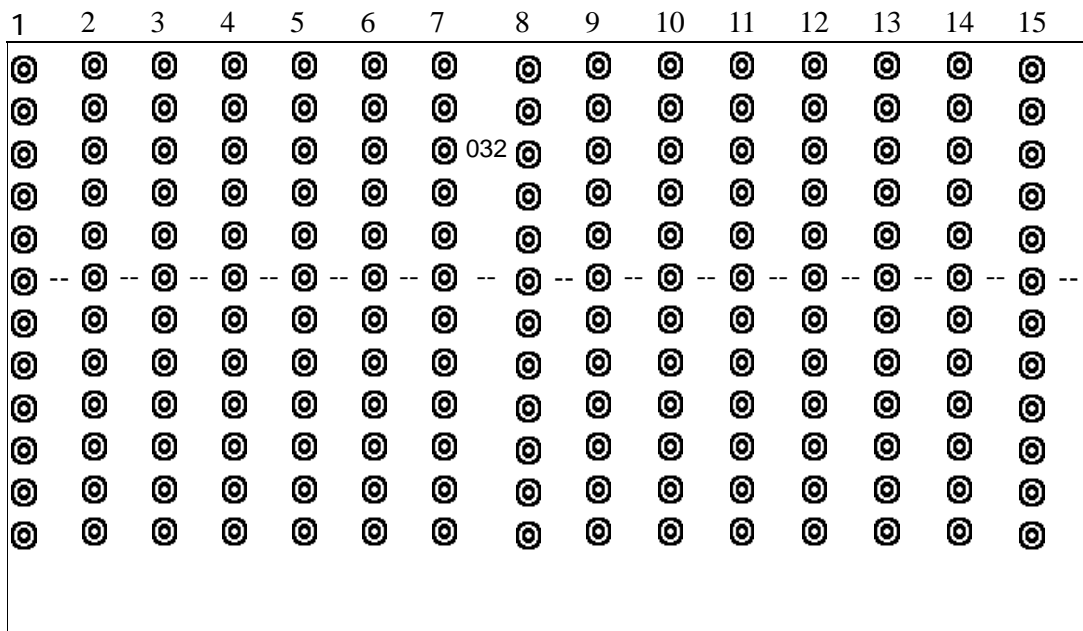

Figure 1-3 MOTION DETECTION SETUP – ALL



3.11 Event

3.11.1 Enter "Event" list

Press "**MENU**" to enter main menu. You will need to enter password to access main menu. Press "**Left**" or "**Right**" to move digit, and to press "**Up**" or "**Down**" to select number. To press "**ENTER**" button to confirm password.

Ex.: Password: 0000 (Default: 0000)



After keying in correct password, and confirm by pressing "**ENTER**" button, Following screen will be displayed. SEARCH ----- find recorded list

TIMER ----- scheduling Record
RECORD----- Record Mode Setup
CAMERA ----- Camera Channel Setup
SYSTEM ----- System Setup
EVENT ----- Event List

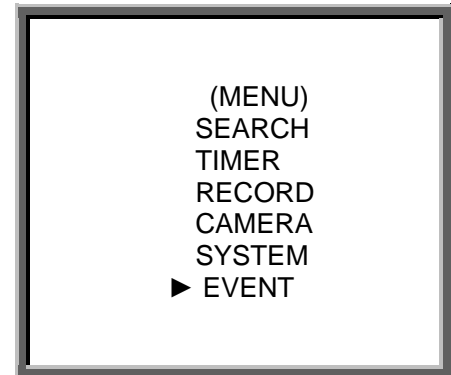

Press "**ENTER**" to confirm Full List, and the screen will be as right displayed. Press "**Up**" or "**Down**" to choose wanted recorded event (Only 8 recorded events will be shown on a single page), and press "**Left**" or "**Right**" to change the pages. Press "**ENTER**" to Play selected recorded video

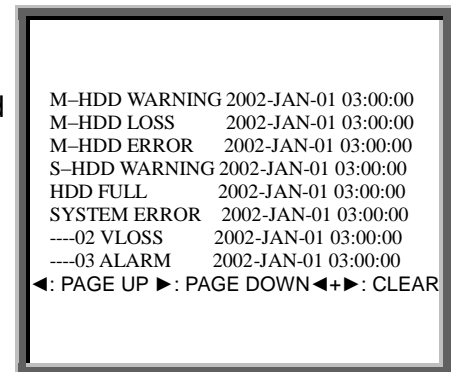

M-HDD WARNING: Master HDD might be failed.

M-HDD LOSS: Master HDD does not exist. Now user can use the other HDD.

M-HDD ERROR: Master HDD might be error

S-HDD WARNING: Slave HDD might be failed

S-HDD LOSS: Slave HDD does not exist. Now user can use the other HDD.

S-HDD ERROR: Slave HDD might be error

HDD FULL: HDD is full

SYSTEM ERROR: System might be failed

----02 VLOSS: Channel: 2 Video loss

----03 ALARM: Channel: 3 External I/O Alarm have triggered

POWER RESTORE : Power restore

4. Operation

4.1 Power on

Before powering on the unit, make sure the HDD has been locked, and the POWER LED is red color now. After pressing POWER button, POWER LED will turn to orange color, then all other LED light will turn to RED color except the LED for HDD. OSD screen will display “HDD Detecting”, Power on running time will take approximately 15 to 20 seconds. If HDD is set as Master, and screen will display “ MASTER HDD CONNECTED”. If HDD is set as Slave, and screen will display “SLAVE HDD CONNECTED”. In order to shorten the power on running time, we suggest set the HDD as Master. After set DMR power on, POWER LED will turn to green color. (You can set up HDD to be Master or Slave by jumper setting on HDD.)

4.2 Recording

Your DMR offers a variety of flexible recording modes. You can set it up to record continually, scheduled time, or by record events, and you can also set up recording speed and resolution. You can set these options by selecting MENU and System before recording. Under the recording status, if power is stopped accidentally, recorded video will still store in the HDD after power on. DMR will continue with original recording setup after power return.

There are 4 record modes for DMR: Alarm Record, Timer Record, Manual Record and Motion Trigger Record. All record modes descriptions in followings.

4.2.1 Alarm Record

When DMR is triggered by alarm input, it will start to record immediately. Following screen will be displayed.

A : Alarm trigger
OW : HDD Over Write
032GB : If the OW location shows 32GB, it means that 32 GB HDD left for video recording. (1 HDD installed)

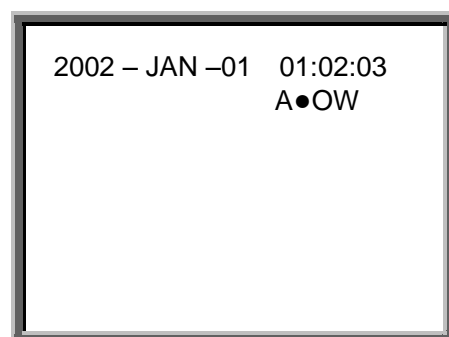

4.2.2 Timer Record

DMR will follow Timer setup to record, and the recording speed and quality will be followed TIMER recording mode setup in main menu.

The screen will be as right displayed.

T : Timer record

OW : HDD Over Write

032GB : If the OW location shows 32GB, it means that 32 GB HDD left for video recording. (1 HDD installed)

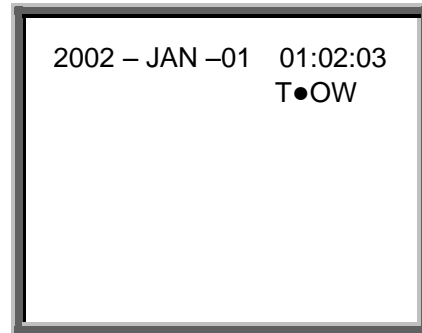

4.2.3 Manual Record

You can press “**REC**” to start recording immediately. The recording speed & quality will be followed by “Record” recording mode setup in main menu.

Following screen will be displayed.

M : Manual record

OW : HDD Over Write

032GB : If the OW location shows 32GB, it means that 32 GB HDD left for video recording.

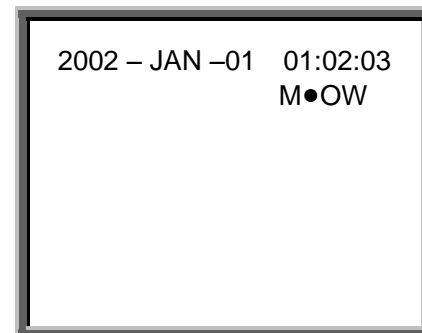

NOTE: If the HDDs' capacity is only 5 GB left, it will buzz for 3 seconds; so as in 4GB, 3GB, 2GB and 1GB. If the O/W Recording mode(NOTE 1) is on, it won't have the warning buzzer.

4.2.3 Motion Trigger Record



Recording is triggered by motion detection. Indicated by the letter “D” and show  diagram on the triggered channel.

4.3 Camera Select (1-9)

Press Camera Select (1-9) to select appointed camera to display on full screen mode.

4.4 Select

This device allows user to get the ideal view size.

4.4.1. Press , ,  button to make different view size.

4.4.2 Press “**Select**” then “**Left**” or “**Right**” button to locate the desired position.

4.4.3 Press “ **Camera Select (1-9)** ” to select the appointed camera.

4.4.4 Press “ **Menu** ” to exit.

4.5 **Piture in Picture (PIP)**

Press PIP  button to enter PIP display screen. The PIP format displays a full screen “background” picture with a 1/16 size screen ‘insert”.

4.5.1 Press  button to display the last selected PIP mode.

4.5.2 Press “ **Select** ” then “ **Left** ” or “ **Right** ” button to move the insert screen.

4.5.3 Press “ **Menu** ” to exit

4.6 **Zoom**

Press ZOOM button to enlarge the display of main picture. It displays zoom picture on main picture and a small window inserted. The inserted window contains a movable 1/4 view size of the appointed camera.

4.6.1 Press the appointed “ **Camera Select (1-16)** ”.

4.6.2 Press “ **Zoom** ” button to be zoom mode.

4.6.3 Press the “**Zoom** ” button again to move the zoom pointer.

4.6.4 Press “ **Menu** ” to exit.

4.7 **Play**

Press “ **PLAY** ” then DMR will enter the Play mode; it will show the last record.

4.7.1 Fast Forward (F.F.) & Fast Rewind (F.R.)

4.7.1.1 Press “ **PLAY** ” and press “ ►► ” for fast forward searching screen. Press once “ ►► ” to get speed for 2X. To press twice “ ►► ” to get speed for 4X, ...And the maximum speed can be 32X.

4.7.1.2 Press “ **PLAY** ” then Press “ ◀◀ ” for fast rewind searching screen. Press once “ ◀◀ ” to get speed for 2X. To press twice “ ◀◀ ” to get speed for 4X, ... and the maximum speed can be 32X.

4.7.2 Slow Forward (S.F.) & Slow Rewind (S.R.)

4.7.2.1 Press “ **PLAY** ” then press “ **SLOW** ” for slow play, To press once “ ►► ” for slow forward speed 1/2X. and press twice “ ►► ” speed for 1/4X,the minimum slow speed can be 1/32X.

4.7.2.2 Press “ **PLAY** ” then press “ **SLOW** ” for slow forward, To press once “ ◀◀ ” for slow rewind speed 1/2X, and press twice “ ◀◀ ” speed for 1/4X,the minimum slow speed can be 1/32X.

4.7.3 Pause : Press “ **PLAY** ” then press “ **PAUSE** ”, it will pause the screen

4.7.4 Stop : Press “ **STOP** ” under any circumstance, it will return DMR to live monitoring mode.

4.7.5 Image jog dial

4.7.5.1 Press “ **PLAY** ” then press “ **PAUSE** ”, it will pause the screen. Then press “ ▶▶ ” for single image play, it will show recorded image one by one when continuously pressing the ” ▶▶ ”.

4.7.5.2 Press “ **PLAY** ” then press “ **PAUSE** ”, it will pause the screen. Then press “ ◀◀ ” for single image play, it will show recorded image one by one by continuously pressing the ” ◀◀ ”.

4.8 VIDEO LOSS

Screen will display “  ” if the video input is not connected properly.

4.9 KEY LOCK WITH PASSWORD

Press “ **MENU** ” and “ **ENTER** ” key at same time, Screen will display “ KEY LOCK ” it will be going to the Key Lock function.

Press “ **MENU** ” and “ **ENTER** ” key again at the same time, key in password and press “ **ENTER**”, Screen will display “ KEY UNLOCK ” it will stop the Key Lock function.

5. Trouble shooting & Appendix

5.1 Trouble shooting

When DMR appears a malfunction; it may be not serious and can be corrected. The table below describes some typical problems and their remedies. Check them before calling your DMR dealer:

PROBLEM	REMEDY
HDD Not Found	<ul style="list-style-type: none"> Please Insert HDD Please use the Key to lock the HDD Cartridge And press any key
No power	<ul style="list-style-type: none"> Check power cord connections. Confirm that there is power at the outlet.
Not working when press any button	<ul style="list-style-type: none"> Check if it is under Key Lock mode. Press "MENU" & "ENTER" at same time to exist Key Lock mode.
No recorded video	Check if the HDD is installed properly.
Timer Record enable does not working	Check if the Record Enable is set to YES
No live video	<ul style="list-style-type: none"> Check camera video cable and connections. Check monitor video cable and connections. Confirm that the camera has power. Check camera lens setting.

Compatible HDD brands

Manufacturer	Model	Capacity	Rotation
HITACHI	Deskstar 180 GXP (120 GB)	120GB	7200 rpm
HITACHI	Deskstar 7K250, HDS722516VLAT20	160GB	7200rpm
HITACHI	Deskstar 7K250, HDS722525VLAT80	250GB	7200rpm
IBM	Deskstar 120GXP (80GB)	80GB	7200 rpm
IBM	Deskstar 120GXP (120GB)	120GB	7200 rpm
Maxtor	DiamondMax 536DX(60GB) 4W060H4	60GB	5400rpm
Maxtor	DiamondMax Plus 9	80GB	7200 rpm
Maxtor	DiamondMax Plus 9, Model#6Y120L	120GB	7200 rpm
Maxtor	DiamondMax Plus 9, Model#6Y160L0	160GB	7200rpm
Seagate	Barracuda ATA IV, ST380021A	80GB	7200rpm
Seagate	Barracuda ATA V, ST3120023A	120GB	7200 rpm
Seagate	Barracuda 7200.7 Plus, ST3160023A	160GB	7200 rpm
Western Digital	Caviar WD1200BB-00CAA1	120GB	7200rpm

Note 1: The models and manufactures of HDD listed above have been tested and proven compatible with this appliance.

Note 2: Please remove hard disk drive ONLY after power was shut off for more than 60 seconds. This would protect and extend the operating life of the hard disk drive.

Note 3 :

Master or Slave HDD should be set up before HDD Jumper.

Note 4 :

Cable Select is suggestive for HDD Jumper.