

# User's Manual

500W V1.2

## Intelligent & Triplex 4CH MPEG-2 DVS

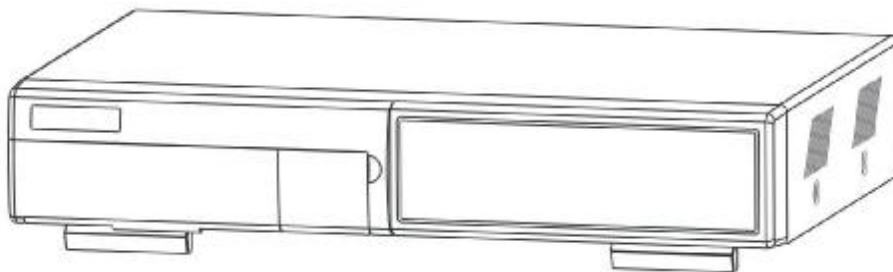

**CP**  
CAM

Please read the instructions thoroughly before operation and retain it for future reference.

## **WARNING**

***All the safety and operating instructions should be read before operation.  
The improper operation may cause permanent damage.***



- This adaptor is only for this machine.  
Do not use it for other electronic products or it will damage other products.
- Please lift and place this equipment gently.
- Do not expose this equipment to direct sunlight.
- Do not use this equipment near water or in contact with water.
- Do not spill liquid of any kind on the equipment.
- Please power down the unit before unplugging.
- Do not block the ventilation holes at the top and bottom of the unit.
- Do not switch the Power On & Off within short period of time  
(within 3 seconds).
- Installation should be made by qualified service personnel.

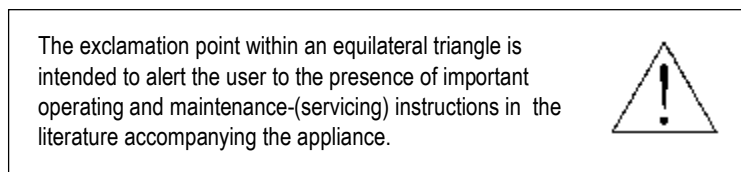
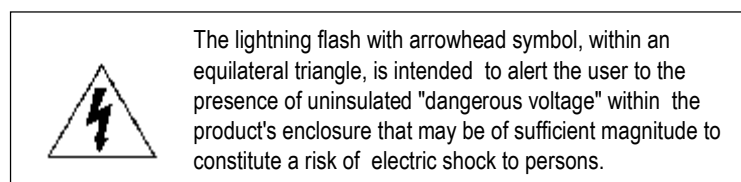



# TABLE OF CONTENTS

|   |    |
|---|----|
| <b>1. What do you get ?</b>                       |    |
| FEATURES - - - - -                                | 1  |
| PACKAGE CONTENT - - - - -                         | 1  |
| SPECIFICATIONS - - - - -                          | 2  |
| <b>2. Before Operation</b>                        |    |
| INSTALLATION GUIDE - - - - -                      | 3  |
| FRONT PANEL - - - - -                             | 4  |
| REAR PANEL - - - - -                              | 5  |
| <b>3. Basic Operation</b>                         |    |
| GETTING STARTED - - - - -                         | 6  |
| OPERATION - - - - -                               | 7  |
| RECORDING FUNCTION - - - - -                      | 7  |
| PLAYBACK FUNCTION - - - - -                       | 7  |
| <b>4. Detailed Menu Setup</b>                     |    |
| MAIN MENU - - - - -                               | 9  |
| MENU OPTIONS - - - - -                            | 10 |
| RECORD SETTING - - - - -                          | 10 |
| TIMER SETUP - - - - -                             | 11 |
| CAMERA SETTING - - - - -                          | 12 |
| DETECTION SETTING - - - - -                       | 13 |
| DISPLAY SETTING - - - - -                         | 15 |
| PIP SETUP - - - - -                               | 16 |
| DWELL SETUP - - - - -                             | 17 |
| USER SETTING - - - - -                            | 17 |
| SYSTEM SETTING - - - - -                          | 18 |
| BUZZER SETUP - - - - -                            | 19 |
| UPGRADE SETUP - - - - -                           | 19 |
| EVENT SETTING - - - - -                           | 20 |
| NETWORK - - - - -                                 | 20 |
| PTZ - - - - -                                     | 21 |
| RETR - - - - -                                    | 21 |
| <b>5. Advanced Operation</b>                      |    |
| OPERATION OPTIONS - - - - -                       | 22 |
| 2X ZOOM - - - - -                                 | 22 |
| VIDEO LOSS - - - - -                              | 22 |
| SEARCH MODE - - - - -                             | 23 |
| USB BACKUP - - - - -                              | 24 |
| KEY LOCK - - - - -                                | 25 |
| <b>6. Network setting guide</b>                   |    |
| HARDWARE CONNECTION AT SERVER SIDE - - - - -      | 26 |
| SOFTWARE INSTALLATION - - - - -                   | 27 |
| LOCAL SETTING - - - - -                           | 28 |
| STATIC IP SETTING - - - - -                       | 30 |
| DYNAMIC IP SETTING - - - - -                      | 31 |
| SOFTWARE OPERATION AT CLIENT SIDE - - - - -       | 39 |
| INTRODUCTION OF BASIC OPERATION - - - - -         | 39 |
| PLAYBACK OPERATION - - - - -                      | 40 |
| ADVANCED SETTING - - - - -                        | 41 |
| CONNECT VIDEO WEB SERVER VIA IE BROWSER - - - - - | 44 |
| <b>7. F &amp; Q</b>                               |    |
| TROUBLESHOOTING - - - - -                         | 45 |
| <b>8. APPENDIX</b>                                |    |
| APPENDIX A – INSTALL THE HDD - - - - -            | 46 |
| APPENDIX B – REPLACE THE HDD - - - - -            | 47 |
| APPENDIX C –RECORDING SPEED - - - - -             | 47 |
| APPENDIX D – PIN CONFIGURATIONS - - - - -         | 48 |

## What do you get ?

### FEATURES

- R.E.T.R (Remote Event Trigger Recording)
- Remote control via the internet
- Control PTZ camera
- MPEG-2 compression format
- Triplex function (record, playback and live at the same time)
- USB Backup ( backup files by USB Sticker and USB HDD devices)
- More accurate motion detection function
- Connect video web server via IE browser
- Auto sending message by e-mail or FTP when alarm occurs
- High resolution: 720 X 480 pixels <NTSC> 720 x 576 pixels <PAL>
- Picture-in-Picture (PIP) in live
- Alarm input & output function
- Linear Zoom (2x)
- Recording rate: Up to 30 frames/sec (NTSC) ; Up to 25 frames/sec (PAL)
- Support 1 removable HDD, IDE TYPE.
- Quick multiple search by event / time list
- Security password protection

### CONTENT

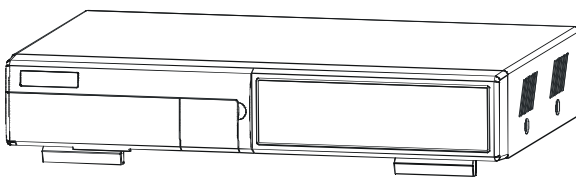

Digital Video Recorder(with HDD cartridge)



User's Manual



2 Keys



Accessories pack



Accessories pack



Power Adapter and Cord



CD-ROM

#### Warning:

1. Please check the package to make sure that you receive the complete accessories shown above.
2. The adaptor is DC19V 2A. If it is damaged, users can find replacement adaptor locally with this specification.

## SPECIFICATIONS

Specifications are subject to change without notice.

|                                  |  |
|----------------------------------|--|
| <b>Video format</b>              | NTSC/EIA or PAL/CCIR   |
| <b>Hard disk storage</b>         | IDE type, UDMA 66, supported 500 GB HDD  |
| <b>Camera Input Signal</b>       | Composite video signal 1 Vp-p 75Ω BNC, 4 channels                                  |
| <b>Network Interface</b>         | Ethernet (10/100 Base-T)   |
| <b>Protocols</b>                 | TCP/IP, ICMP, SMTP, HTTP, FTP  |
| <b>Resolution</b>                | 720 x 480 pixels <NTSC> , 720x576 pixels <PAL>                                     |
| <b>Recording Mode</b>            | Manual / Timer / Alarm (Remote) / Motion (Remote)                                  |
| <b>Main Monitor Output</b>       | Composite video signal 1 Vp-p 75Ω BNC  |
| <b>Call Monitor Output</b>       | Composite video signal 1 Vp-p 75Ω BNC  |
| <b>Motion Detect Area</b>        | 16 * 12 targets per camera   |
| <b>Motion Detect Sensitivity</b> | 16 levels  |
| <b>Video Loss Detection</b>      | Yes  |
| <b>USB Interface</b>             | 1 port. Support USB 1.1 Device <sup>⊕</sup>  |
| <b>Refresh Rate</b>              | 120 frames/sec. for NTSC / 100 frames/sec. for PAL *                               |
| <b>Recording Rate</b>            | Up to 30 frames/sec. for NTSC / 25 frames/sec. for PAL                             |
| <b>Dwell Time</b>                | Programmable (0~24 Sec)  |
| <b>Picture in Picture</b>        | Yes  |
| <b>Key Lock</b>                  | Yes  |
| <b>Picture Zoom</b>              | 2X   |
| <b>Camera Title</b>              | 8 letters  |
| <b>Video Adjustable</b>          | Hue/ Color/ Contrast/ Brightness Adjustable  |
| <b>Alarm Input</b>               | TTL input, Hi (5V), Low (GND)  |
| <b>Alarm Output</b>              | COM./N.O./N.C  |
| <b>Trigger &amp; Action</b>      | E-Mail images or images uploading to FTP site's specific account/ Remote Recording |
| <b>Web Interface</b>             | Yes  |
| <b>Time Display Format</b>       | YY/MM/DD, DD/MM/YY, MM/DD/YY, OFF  |
| <b>Power Source</b>              | DC 19V   |
| <b>Power Consumption</b>         | <32W   |
| <b>Operation Temperature</b>     | 10°C ~ 40°C (50°F ~ 104°F)   |
| <b>Dimension (mm)</b>            | 343(W) x 223(L) x 59(H)  |

<sup>⊕</sup>NTSC: 4CH x 30IPS = 120 frames/sec, PAL: 4CH x 25IPS = 100 frames/sec

# Before Operation

## INSTALLATION GUIDE

1. Table below is an example of connecting the DVR to existing Observation System.

2. Install HDD (The compatible HDD models are listed in the following table).

Please refer to [page 46](#) Appendix A for installation instructions.

**Note:** 1. The HDD must be installed before turning on the DVR. If HDD is not installed, the DVR would function as a 4 CH multiplexer.

2. Users need to set the HDD on the Master mode for system detecting.

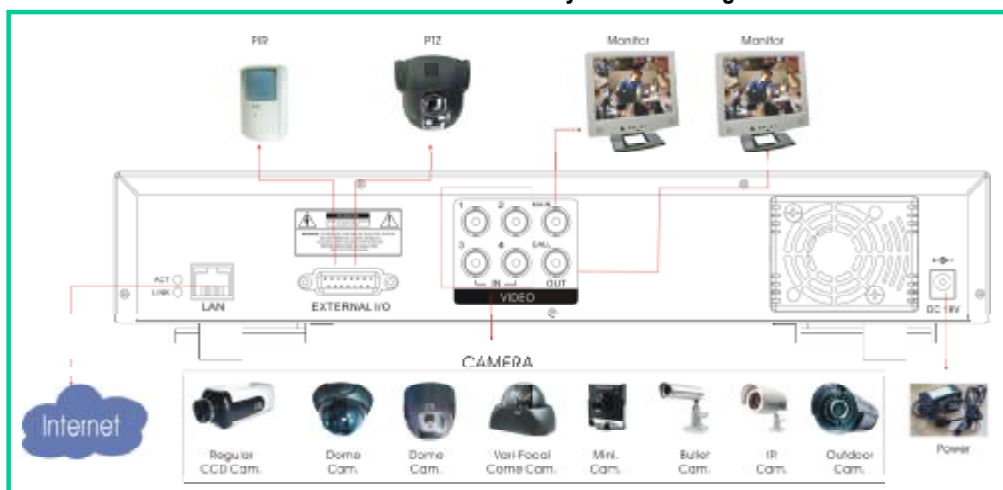





## COMPATIBLE HARD DISK MODELS

| Manufacturer    | Model                             | Capacity | Rotation |
|-----------------|-----------------------------------|----------|----------|
| HITACHI         | Deskstar 180 GXP (120 GB)         | 120GB    | 7200 rpm |
| HITACHI         | Deskstar 7K250, HDS722516VLAT20   | 160GB    | 7200 rpm |
| HITACHI         | Deskstar 7K250, HDS722525VLAT80   | 250GB    | 7200 rpm |
| IBM             | Deskstar 120GXP (80GB)            | 80GB     | 7200 rpm |
| IBM             | Deskstar 120GXP (120GB)           | 120GB    | 7200 rpm |
| Maxtor          | DiamondMax 536DX(60GB) 4W060H4    | 60GB     | 5400 rpm |
| Maxtor          | DiamondMax Plus 9                 | 80GB     | 7200 rpm |
| Maxtor          | DiamondMax Plus 9, Model#6Y120L   | 120GB    | 7200 rpm |
| Maxtor          | DiamondMax Plus 9, Model#6Y160L0  | 160GB    | 7200 rpm |
| Maxtor          | MaxLine Plus II , Model#7Y250P0   | 250GB    | 7200 rpm |
| Seagate         | Barracuda ATA IV, ST380021A       | 80GB     | 7200 rpm |
| Seagate         | Barracuda ATA V, ST3120023A       | 120GB    | 7200 rpm |
| Seagate         | Barracuda 7200.7 Plus, ST3160023A | 160GB    | 7200 rpm |
| Western Digital | Caviar WD1200BB-00CAA1            | 120GB    | 7200 rpm |
| Western Digital | Caviar WD2000BB-00DWA0            | 200GB    | 7200 rpm |
| Western Digital | CaviarSE WD2500JB                 | 250GB    | 7200 rpm |

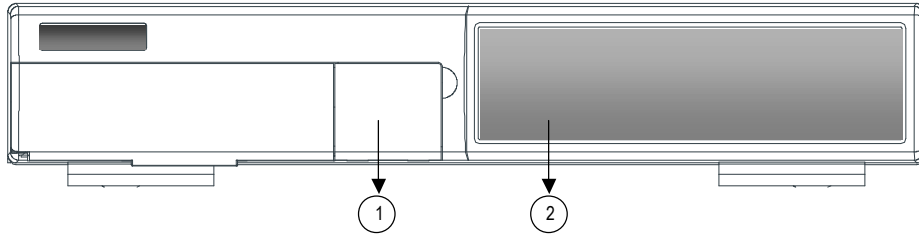
**NOTE:** For non-stop long-time recording, we suggest to have two HDDs for recording to ensure good reliability of HDD.

## FRONT PANEL



|   |   |
|---|---|
| 1. REMOVABLE HDD CARTRIDGE & KEYHOLE  | Please refer to page 47 Appendix #B.  |
| 2. CONTROL PANEL  |   |
| LED LIGHT   | <p>The LED Light is ON under the following conditions.</p> <ul style="list-style-type: none"> <li>• HDD : HDD is reading or recording.</li> <li>• HDD Full : HDD is full .</li> <li>• ALARM : To turn off the ALARM LED light, please refer to page 14 and set the ALARM mode as OFF.</li> <li>• TIMER : When Timer is Enabled.</li> <li>• PLAY : Playing mode.</li> <li>• REC : Recording mode.</li> </ul> |
| MENU  | Press <b>MENU</b> button to enter main menu.  |
| ENTER   | Press <b>ENTER</b> button for confirmation.   |
| SEARCH  | Press <b>SEARCH</b> button for searching recorded video.  |
| Zoom  | Press <b>ZOOM</b> button to enlarge the picture display.  |
|  / + PICTURE IN PICTURE      | <p>PIP: Press "<b>PIP</b>" button for Picture in Picture screen.</p> <p>+ : Press "+" button can change the setting in the menu.</p>  |
|  / - 4 CHANNELS DISPLAY MODE | <p>Press "</p> button for 4 CH display modes and press twice to enter POP (Picture On Picture) function. <p>- : Press "-" button can change the setting in the menu.</p>   |
| SLOW  | To slow down the speed of playing mode.   |
| POWER   | Press Power to turn ON / OFF the DVR.   |
| FF / ►  | <ul style="list-style-type: none"> <li>• FF : Play video fast forward. (Press FF button again to adjust speed as 3, 45, 600 times)</li> <li>• ► : Under setup mode, it works as Right button.</li> </ul>  |
| REW / ◀   | <ul style="list-style-type: none"> <li>• REW : Play video fast backward. (Press REW button again to adjust speed as 15, 90, 600 times).</li> <li>• ◀ : Under setup mode, it works as Left button.</li> </ul>  |
| STOP / ▼  | <ul style="list-style-type: none"> <li>• STOP : Under DVR Recording / Playing mode, it can stop the action.</li> <li>• ▼ : Under setup mode, it works as Down button.</li> </ul>  |
| PAUSE / ▲   | <ul style="list-style-type: none"> <li>• Pause : Under DVR playing mode, it can make the action pause.</li> <li>• ▲ : Under setup mode, it works as Up button.</li> </ul>   |
| PLAY  | Press " <b>PLAY</b> " button to playback recorded video.  |
| REC   | Press " <b>REC</b> " to start recording.  |
| CAMERA SELECT (1-4)   | Press the Camera Select (1-4) to select the camera.   |
| ENTER + SEARCH  | Press both "ENTER" and "SEARCH" buttons to enter the USB Backup Menu.   |
| ENTER + ZOOM  | Press both "ENTER" and "ZOOM" buttons to start the PTZ operation mode.  |
| MENU + ENTER  | Press both "MENU" and "ENTER" buttons to Lock/Unlock the keyboard.  |
| REC + STOP  | Press both "REC" and "STOP" buttons to inactivate RETR.   |
| REC + PLAY  | Press both "REC" and "PLAY" buttons to activate RETR.   |

## REAR PANEL

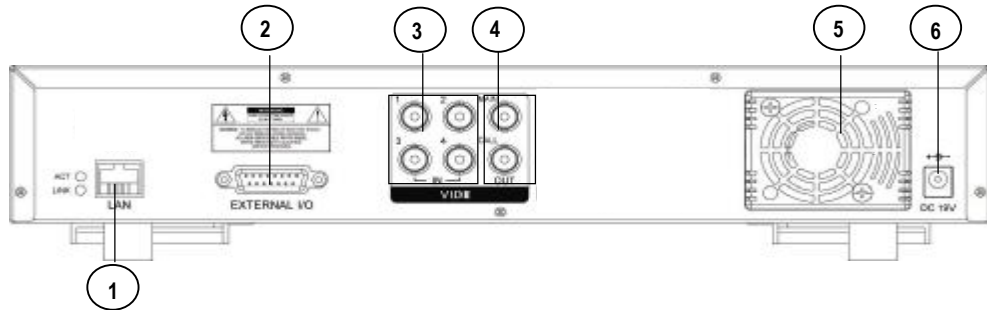

### 1. LAN

Connect DVR by LAN cable.

### 2. EXTERNAL I/O

- Controlled remotely by an external device or control system such as Video Web Server or PC.
- Alarm input, external I / O expansion.

### 3. VIDEO INPUT (1-4)

Connect to video source, such as camera.

### 4. MAIN AND CALL MONITOR

Connect to the main monitor.

Connect to CALL monitor. Show the Switch Display.

When alarm trigger happens, it will change to dwell modes of alarm.

### 5. FAN

For ventilation, do not block the opening.

### 6. POWER

Please use the provided power cord.

#### Warning:

1. The adaptor is only for this machine. Do not use it for other electronic product or it might damage other products.
2. The adaptor is DC19V 2A. If it is damaged, users can find replacement adaptor locally with this specification.

## GETTING STARTED



1. Connect the AC power cord and plug into an electrical outlet. The Red LED indicator light will be ON and the DVR is in Standby mode.
2. Press the Power button. The POWER LED will turn from red to orange, and other red LED indicators will be turned ON. It takes approximately 5 to 15 seconds to boot the system with the message : “ HDD Detecting ”. Once connected, the POWER LED will change to color green, and the Alarm LED will be ON.
3. Before operating the DVR, set the system time first. (refer to page18).

**NOTE : 1. If the HDD is not installed correctly or not installed, the “NO HDD!”, “HDD KEY UNLOCK!”, “UNKNOWN FILE SYSTEM! PLEASE FORMAT IT!” messages will appear for 3 seconds, and then return to 4 CH Multiplexer display mode.**

**\*\*\* “UNKNOWN FILE SYSTEM!”: The format of HDD is not accepted by the DVR system. The system only accepts EXT3 format. Users can format HDD by selecting “HDD FORMAT” on SYSTEM menu.**

- 2.. To switch the system, you need to turn off the power and pull out the AC power cord. Before you reconnect the power, press “FF” to NTSC system or “REW” to PAL system and then reconnect to the AC power cord and then the DVR will be auto-detecting.

**(warning: Please confirm that the power of the machine is off before unplugging the power cord.**

**Moreover, if the power system is unstable, we suggest installing UPS .)**

## OPERATION

### RECORDING

The DVR offers 2 recording modes(Timer and Manual). Under the recording status, if power is off accidentally, the recorded video will still be stored in the HDD. DVR will return to previous original recording setting after power restores.





Ab 007.2 GB O/W

The first character: ( Frame/Sec)  
A : 30 <NTSC> 25 <PAL>  
B : 15 <NTSC> 12 <PAL>  
C : 5 <NTSC> 4 <PAL>  
The second character: (Record Quality)  
a : Best b : High c :Normal d : Basic  
007.2 GB: the capacity of HDD is available  
O/W: HDD is overwritten

**NOTE :** Under O/W Recording mode, previously recorded files will be automatically overwritten.

#### 1. TIMER RECORDING

Recording is scheduled by a Timer. It will indicate by the symbol  and .

#### 2. MANUAL RECORDING

Recording is initiated manually by pressing the **REC** button. Symbol  will be shown.

If the system is shut down, the system will resume recording automatically.

### PLAY BACK

Press the "PLAY" and select the channel which you want to display on the middle of the screen and press the enter bottom.

When users select the channel, users can also press the number buttons on the front panel.



Press "PIP" button to change the Location of channel which users just set up.



Press "ENTER" button to enlarge the video to full screen.



### 1. F.F. (FAST FORWARD) & F.R. (FAST REWIND)

Increase the speed of Fast Forward and Rewind on the DVR by pressing the “**FF**” button.

In the Play mode, press “▶” once to get 3X speed forward and press twice to get 45X speed,... and the maximum speed to reach 600X.

Press “◀” once to get 15X speed rewind and press twice to get 90X speed, ... and the maximum speed can reach 600X.

### 2. S.F. (SLOW FORWARD)

Slow down the speed of Forward on the DVR by pressing the “**SLOW**” button.

In the Play mode, press the “**SLOW**” button to enter the Slow mode.

Press “**SLOW**” once to get 1/4X speed forward and press “▶” to get 1/8 speed,... and the slowest speed can reach 1/16X.

### 3. PAUSE

The image will be motionless and displayed on the screen.

### 4. STOP

Press “**STOP**” button to stop displaying a video.

### 5. IMAGE JOG DIAL

It will allow you to view video frame-by-frame manually, one image at a time.

In PLAY mode, press “**PAUSE**”, it will pause the video.

Press “▶” button advances one step.

Press “◀” button moves back one image.

NOTE: Under overwriting and duplex modes, when the playback motion is interrupted by unknown causes, please press “**Stop**” and then the “**PLAY**” button to start playing again.

## ■ Detailed Menu Setup

### MAIN MENU

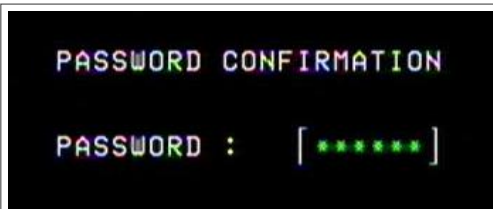

Press “MENU” button to enter the main menu at first time.

The default password is 000000. Please press “ENTER” menu six times to enter the menu when the password is default value.

There are 10 options available in the Main Menu.

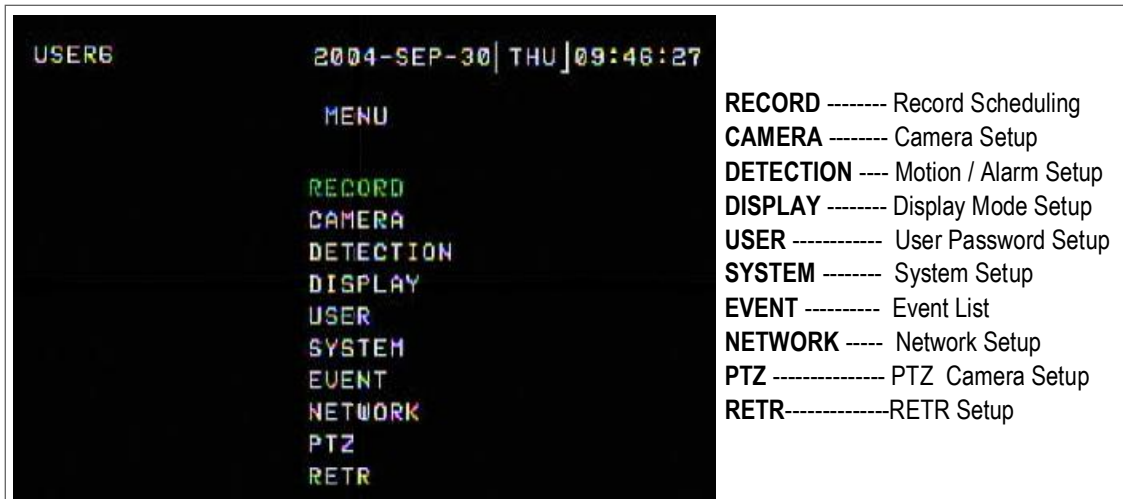

The following buttons are used for menu setting :

- “▲” “▼” “◀” “▶” : Move the cursor.
- “+” and “-” : Select the numbers/ change values.
- ENTER : Enter a submenu mode / an option under a submenu for browsing / Confirm the selection.
- MENU : Enter the menu mode / Confirm the change/ Exit a menu.

## MAIN OPTIONS

### RECORD

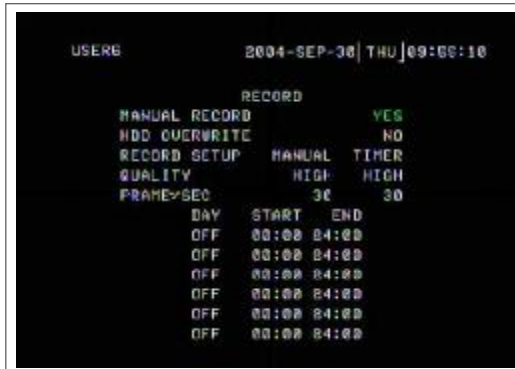

Press the “▲” “▼” “◀” “▶” buttons to move the cursor.

Press the “+” “-” buttons to change the digit.

Press the “MENU” button to confirm the changes/ to exit the menu.

#### 1. STOP RECORD

The system will stop manual recording function during the recording period if the setting is “NO”. And then, press the “ENTER” button to save the changed value.

**Note: 1. The users have to stop recording function on this menu because the users cannot stop it by pressing any front-panel buttons during the recording period.**

**2. On the Timer Recording mode, users have to either change the RECORD METHOD setting from TIMER to MANUAL or change the timer setting to stop the timer recording function.**

#### 2. FRAME / SEC

Select the recording speed. The options are as following : **NTSC**—30、15、5 **PAL**—25、12、4

#### 3. QUALITY

There are four image qualities : BEST, HIGH, NORMAL, BASIC.

#### 4. HDD OVERWRITE

To set the HDD OVERWRITE. When the HDD is going to be full under O/W recording mode, previously recorded files will be overwritten without further warning notices if the HDD OVERWRITE is “ON”.

#### 5. RECORD METHOD

There are two recording methods: MANUAL ( by pressing the “REC” button) and TIMER ( by setting the timer recording).

**\*\*\*On the Timer Recording mode, users have to either change the RECORD METHOD setting from TIMER to MANUAL or change the timer setting to stop the timer recording function.**

## **TIMER SETUP**

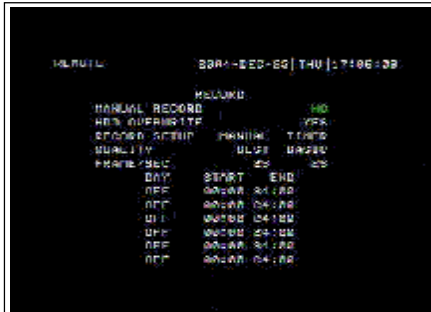

Press the “▲” “▼” “◀” “▶” buttons to move the cursor.

Press the “+” “-” buttons to change the digit.

Press the “MENU” button to confirm the changes/ to exit the menu.

### **1. DAY**

Choose the day for recording. The options are:

MON(Monday) , TUE (Tuesday), WED (Wednesday), THR (Thursday), FRI (Friday), SAT (Saturday),SUN (Sunday),  
MO-FR (Monday to Friday), SA-SU (Saturday to Sunday), OFF, and DAILY(on each day).

\* Date could be changed by “+” and “-” buttons.

### **2. START**

The beginning of recording time.

### **3. END**

The end of recording time.

## **CAMERA**

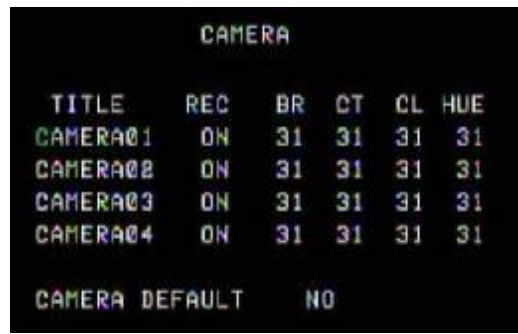

| TITLE          | REC | BR | CT | CL | HUE |
|----------------|-----|----|----|----|-----|
| CAMERA01       | ON  | 31 | 31 | 31 | 31  |
| CAMERA02       | ON  | 31 | 31 | 31 | 31  |
| CAMERA03       | ON  | 31 | 31 | 31 | 31  |
| CAMERA04       | ON  | 31 | 31 | 31 | 31  |
| CAMERA DEFAULT |     | NO |    |    |     |

Press the “▲” “▼” “◀” “▶” buttons to move the cursor.

Press the “+” “-” buttons to change the option/digit.

Press the “MENU” button to confirm the changes/ to exit the menu.

### **1. TITLE**

Assign a title to each channel. The default title is the camera's number (Up to 8 characters).

### **2. REC (RECORD)**

Select a channel to record.

**ON** : when the timer input is triggered, DVR will record a video.

**OFF** : DVR will not record.

### **3. BR (BRIGHTNESS)**

Adjust the brightness of each channel. The level is from 0 to 63.

### **4. CT (CONTRAST)**

Adjust the contrast of each channel. The level is from 0 to 63.

### **5. CL (COLOR)**

Adjust the color of each channel. The level is from 0 to 63.

### **6. HUE (HUE)**

Adjust the hue of each channel. The level is from 0 to 63.

### **7. CAMERA DEFAULT**

The setting of BR/CT/CL/HUE will be back to the default value, which is 31.

## **DETECTION**



Press the “▲” “▼” “◀” “▶” “buttons to move the cursor.

Press the “+” “-” buttons to change the option.

Press the “MENU” button to confirm the changes/ to exit the menu.

### **1. DET (DETECTION)**

The motion detection on each channel can be turned ON or OFF individually.

### **2. AREA**

Press the “ENTER” button to set target-area.

In this function, it is defaulted to detect nothing.

After entering the setting, users will see the pink area, which means the undetected area, and users can set the area to be detected, and which will turn from pink to transparent.

The Pink target represents the undetected area.

The Transparent target represents the Motion Detection Area.



*The beginning of Motion Detection Setting-  
Non activate area*



*Motion Detection Setting-  
One Target undetected*



*Motion Detection Setting –  
A row-target detected*



*Motion Detection Setting –  
A detected target*

▲▼◀▶: navigates between targets.

- : turns all targets on the screen ON/ OFF.

+ : press once to set a motion target, press twice to set a row of motion target..

### 3. LS (Level Sensitivity)

Comparing the difference between two images to allow the system to start motion detection function.

Lower number = higher sensitivity for motion detection. The highest sensitivity setting is 02, the lowest sensitivity setting is 15. The default value is 06.

### 4. SS (Spatial Sensitivity)

Set the number of motion detection targets (from 0-192 target areas). The highest sensitivity setting is 0, and the lowest sensitivity setting is 15. The default setting is 02.

**Note:**The setting of Spatial Sensitivity cannot be more than the number of targets set in the AREA.

### 5. TS (Temporal Sensitivity)

The system will start the motion detection function if the continuous fields are all different.

The highest sensitivity setting is 0, and the lowest sensitivity setting is 15. The default setting is 02.

### 6. RE (REFERENCE)

Set the Reference image to which the current screen is compared (from 0-63).

For example, the value 8 would compare the current image to the 8<sup>th</sup> previous image. The higher value will increase the sensitivity. The default value is 10.

### 7. Alarm

Select LOW / OFF / HIGH for alarm polarity. The default alarm value is LOW.

### 8. Duration Time

You can set durative time of detection.(1, 2, 3, 4, 8, 24, 60), the default value is 02.

### 9. Day, Start, End of Duration

Choose the day for recording, the beginning of recording time and the end of recording time.

**Note:** When the motion detection function is triggered during the recording period. The symbol  will be shown.

When the alarm function is triggered during the recording period. The symbol will be shown  .

## **DISPLAY**



Press the “▲” “▼” “◀” “▶” buttons to move the cursor.

Press the “+” “-” buttons to change the option/digit.

Press the “MENU” button to confirm the changes/ to exit the menu.

### **1. TITLE DISPLAY**

Set the title showing on monitor.

### **2. OSD COLOR**

Select the OSD (On Screen Display) color. The options are WHITE, RED, YELLOW, CYAN, BLUE, PINK, GRAY, ORANGE.

### **3. CURSOR COLOR**

Select the cursor color. The options are RED, YELLOW, GREEN, CYAN, BLUE, PINK, GRAY, ORANGE.

**NOTE: The setting of OSD COLOR and CURSOR COLOR cannot be the same.**

### **4. LOSS SCREEN**

Select a way to display the screen when the video input is out of order. The options are BLACK, BLUE and RETAIN (retain the last picture).

### **5. OSD POSITION**

Select the OSD POSITION. The options are NORMAL (in upper right corner) or CENTER.

### **6. PLAYBACK METHOD**

Select a video type to playback. The options are frame and field. 1 frame equals two fields.

### **7. PIP OPTION / DWELL OPTION(refer to p.16 and 17)**

To enter the PIP setting menu/DWELL setting menu.

## **PIP OPTION**

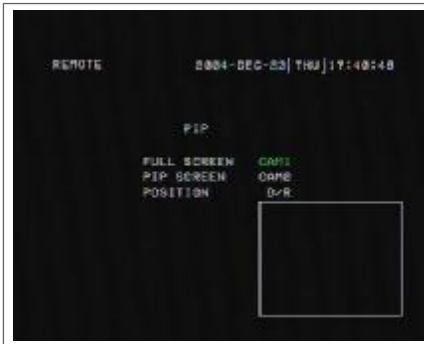

Press the “▲” “▼” buttons to move the cursor.

Press the “+” “-” buttons to change the option.

Press the “MENU” button to confirm the changes/ to exit the menu.

### **1. FULL SCREEN**

The full screen background picture display.

### **2. PIP SCREEN**

The picture with a 1/9 size screen “insert”.

### **3. POSITION**

There are six position settings : D/L (Down/Left), D/M (Down/Middle), D/R (Down/Right), U/L (Up/Left), U/M (Up/Middle), U/R (Up/Right).

## **DWELL OPTION**

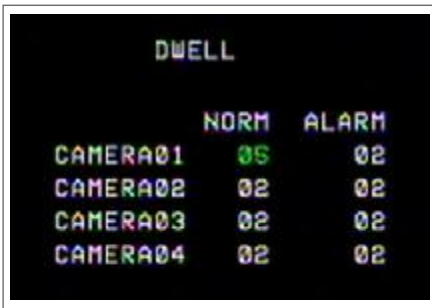

Press the “▲” “▼” “◀” “▶” buttons to move the cursor.

Press the “+” “-” buttons to change the option.

Press the “MENU” button to confirm the changes/ to exit the menu.

### **1. NORM**

To set up the DWELL time period that each channel shows sequentially automatically on call monitor. The level is from 01 to 24 Sec or OFF.

### **2. ALARM**

To set up the DWELL time period when the alarm input is triggered.

The level is from 01 to 24 Sec or OFF.

## **USER**



Press the “▲” “▼” “◀” “▶” buttons to move the cursor.

Press the “+” “-” buttons to change the option/digit.

Press the “MENU” button to confirm the changes/ to exit the menu.

### **1. USER**

To set up the user’s account for controlling. It allows 7 users setting.

**Supervisor** – Control all the functions.

**Other Users** – View all functions except the menu setting and event list cleaning.

### **2. PASSWORD**

To set the security password for each account.

The maximum length of user’s password is 6 digits.

NOTE: When you reset your DVR, please login as supervisor.

1. Unlock the keyboard.
2. Enter the password.
3. Lock the keyboard.

## SYSTEM



Press the “▲” “▼” “◀” “▶” buttons to move the cursor.

Press the “+” “-” buttons to change the setting

Press the “MENU” button to confirm the changes/ to exit the menu

### 1. KEY MUTE

To set the KEY MUTE. When the setting is “ON”, there will be no sound when you press any key.

### 2. BUZZER (refer to page 19 )

To enter the buzzer setup menu.

### 3. MESSAGE LATCH

Select message latch on / off. When this function is on, the message of video loss, alarm, motion detection will be shown on the screen. The default setting of messages latch function is “OFF”.

### 4. DATE DISPLAY

Set the date display. The options are Y/M/D, D/M/Y, M/D/Y and OFF.

### 5. DATE

Set the date.

### 6. TIME

Set the time.

### 7. HDD FORMAT

Format HDD by selecting “FORMATE” option. After formatting the HDD, the system will restart.



Note: 1. The system will take about 12 minutes to format 80 GB HDD.

2. After formatting the HDD, you would find that the space about 12% is occupied.

### 8. SYSTEM RESET

Reset all system settings back to factory default setting.

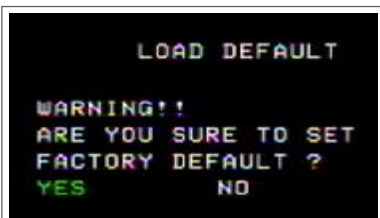

### 9. LANGUAGE

Select one language for menu displaying. The options are ENGLISH and CHINESE. The system will automatically save the setting.

### 10. UPGRADE(refer to page 19 )

To enter the upgrade setup menu.

## **BUZZER SETUP**

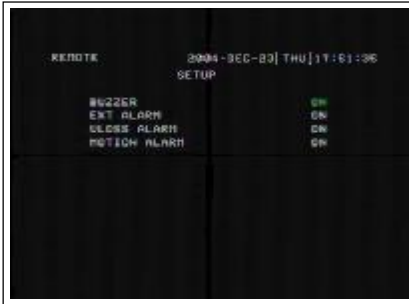

### **1. BUZZER**

Set the BUZZER "ON", it will buzz when event occurs.

### **2. EXT ALARM**

To set the EXT ALARM. It will be triggered by event occurrence when the setting is "ON".

### **3. VLOSS ALARM**

To set the VLOSS ALARM. When the setting is "ON", the alarm will start after setting Buzzer, EXT Alarm or Alarm Duration.

### **4. MOTION ALARM**

To set the MOTION ALARM. When the setting is "ON", the alarm will start after setting Buzzer and EXT Alarm.

## **UPGRADE SETUP**



- Note:
1. Please ask your agent to get the latest firmware.
  2. The file name is "ug784.dat". Please do not change the file name.
  3. If you save it in the USB. Do not put it in the folder.

Users can upgrade the DVR software by USB memory device.

YES: Upgrade

No : Cancel

It will take few minutes to upgrade the whole system. Users cannot unplug the power cord, or turn off the power during the period of upgrading.

The whole system setting will be disable when the system is upgrading.

Therefore, users have to reset all settings after upgrading.

CHECK CRC: The system will check the firmware status to ensure the quality of system.

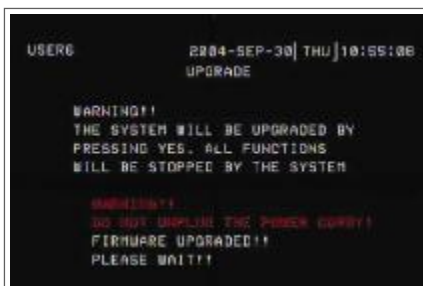

## EVENT



Press the “▲” “▼” buttons to move the cursor.

Press the “ENTER” button to get into the submenu.

The EVENT shows the recording list of different types.

The VIDEO LOSS section lists the record of video loss.

The ALARM LOG section lists the record of triggering by external I/O alarm.

The MOTION LOG section lists the record of triggering by motion detection.

The ALL LOG section lists all types of records.

The DELETE ALL option will delete all records.

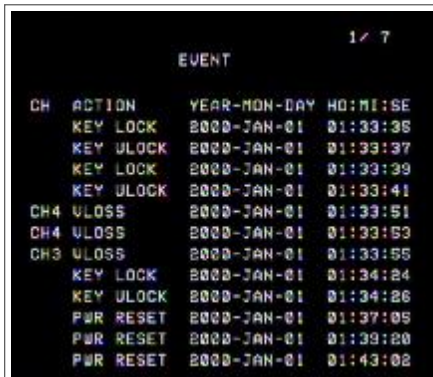

A single page can display 12 recorded events.

Press “◀” or “▶” button to change the pages.

**Note:** The event list show 256 item at most. When the list is over 256, it will overwrite automatically.

PWR RESET: The system will automatically record when the system has been reset.

## NETWORK

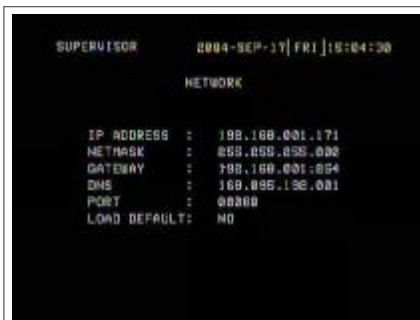

Press the “▲” “▼” “◀” “▶” buttons to move the cursor.

Press the “+” “-” buttons to change the digit.

Press the “MENU” button to confirm the changes/ to exit the menu.

Set IP ADDRESS, NETMASK, GATEWAY, DNS and PORT.

Choose YES in LOAD DEFAULT will go back to default value of NETWORK.

## PTZ



Press the “▲” “▼” “◀” “▶” buttons to move the cursor.

Press the “+” “-” buttons to change the digit.

Press the “ENTER” button to confirm the changes/ “MENU” to exit the menu.

1. Please press ENTER after set NEW ID, then the CURRENT ID and NEW ID will change to the same number which you have set.

2. When the PTZ had been installed, you can see the ID of PTZ on the Screen. Please check that the ID is the same as the ID displayed in PTZ MENU.

## RETR



Press the “▲” “▼” buttons to move the cursor.

Press the “+” “-” buttons to change the digit.

Press the “MENU” button to confirm the changes/ to exit the menu.

Remote Event Trigger Recording is only for PC. When motion-triggered event is detected under R.E.T.R mode, a video playback recording motion event will be transferred and saved on the desktop of computer.

### 1.MODE

You can choose the display mode when the event is triggered.

### 2.RETR DELAY

The RETR DELAY section lists 3 delaying settings, including “03MIN”, “05MIN” and “10 MIN”.

### 3.Control RETR via AP

You can control RETR via AP. Please click “R.E.T.R.” button to activate it.

Note : 1. When you activate it, the color of the button “R.E.T.R.” is red.

2. If you want to return to control RETR via DVR’s panel. Please click “R.E.T.R.” button and enter the password.

The color the button “R.E.T.R.” is blue, when you inactivate it.



## Advanced Operation

### OPERATION OPTIONS

#### **2X ZOOM**

Press the “ZOOM” button, It displays zoomed picture on main picture and a small inserted window.

The inserted window contains a movable 1/4 view size of the appointed camera. The range is 2X.



- Press the “ZOOM” button again to exit the zoom pointer.
- Press Camera 1-4 button to select a channel.
- Press ▲▼◀▶ buttons to move the zoom position.

#### **VIDEO LOSS**

The screen will display “VLOSS” in the center of display picture, if the video input is not connected properly.



## **SEARCH**

Press “SEARCH” button to play the recording.



Select a channel for searching a video record.

Press “▲” “▼” buttons to select camera.

Press the “ENTER” button to get into menu/ submenu

Press the “MENU” button to confirm the changes/exit the menu

## **SEARCH MODE**



Press the “ENTER” button to get into each submenu.

### **1. EVENT SEARCH**

Display all the videos, which have been motion triggered on the recording mode.

Note : When you playback recorded video, it would play with fast speed. And when you press “PLAY” button, it would return to normal speed.

### **2. TIME SEARCH**

Enter a period recording for searching a video.



Press “ENTER” button to move to next digit.

Press “+” “-” button to change the digit.

#### **•Select**

Enter a period of time for searching a video.

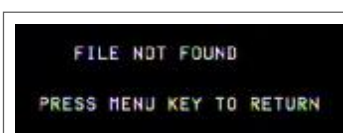

If the users enter a inexistent period, it will show “PRESS MENU KEY TO RETURN”.

After enter the “MENU” button, the screen will back to the previous screen.

### 3. LIST ALL

List all video records.



|     | Y/M/D      | HO:MI:SE | MI:SE | TYPE |
|-----|------------|----------|-------|------|
| 631 | 2004/08/28 | 05:20:00 | 10:00 | D1   |
| 632 | 2004/08/28 | 05:30:01 | 09:59 | D1   |
| 633 | 2004/08/28 | 05:40:00 | 10:00 | D1   |
| 634 | 2004/08/28 | 05:50:01 | 09:59 | D1   |
| 635 | 2004/08/28 | 06:00:00 | 10:00 | D1   |
| 636 | 2004/08/28 | 06:10:00 | 06:43 | D1   |
| 637 | 2004/08/30 | 10:41:12 | 00:03 | D1   |
| 638 | 2004/08/30 | 10:41:15 | 00:27 | D1   |
| 639 | 2004/08/30 | 10:41:40 | 00:22 | D1   |
| 640 | 2004/08/30 | 10:42:14 | 00:06 | D1   |

Press the “▲” “▼” buttons to select one record.

Press the “ENTER” / “PLAY” buttons to display.

#### 1. Y/M/D

The Month and the Date display(Year/Month/Date).

#### 2. HO:MI:SE

The beginning of recording time(Hour:Minute:Second).

#### 3. MI:SE

The duration of playing time(Minute:Second).

#### 4. TYPE

**D1: Multiplex mode** (input images of a channel at a time).

### USB BACKUP



Users may have to format the USB memory device( USB Sticker and USB HDD devices ) by PC before connecting to the DVR.

Press both “ENTER”+ “SEARCH” buttons, enter the USB BACKUP mode.

Users can save files into the USB memory device, and read files by personal computer.

The system will detect the USB memory device automatically. it will show “DETECTING USB DEVICE”

Inside of the symbol [ ] shows the available space of the USB memory device.





Press “◀” “▶” buttons to select a channel or move to the next digit.

Press “+” “-” buttons to change the digit.

Step 1: Choose a certain camera by pressing “◀” “▶” buttons.

Step 2: Enter the beginning and the end of time by pressing “+” “-” buttons.

Step 3: Select OK by pressing “ENTER” button (shows the recording space).

Step 4: Select OK again to start to backup a file.

[ ]/[ ]: [ Recording space ] / [ Total available space of the USB memory device ].

**NOTE:**

1. The USB memory device can only be detected by these three file types:  
FAT32 (WINDOWS), EXT3 (LINUX), EXT2 (LINUX)
2. The system will take a few minutes to search if the file is too large.
3. The backup files can only be read by WinDVD and PowerDVD software.
4. The 4CH recording mode will play as four times speed when you playback recorded video.  
( The same does 3CH and 2CH. 3CH→triple. 2CH→double.)

**KEY LOCK**

For advanced security, users can “Lock” the buttons on your DVR. Key-Lock prevents other people from using the system.

Press “ENTER” + “MENU” at the same time to enable Key Lock.

Press “ENTER” + “MENU” at the same time and key in password (Default : 000000), and then press “ENTER” to disable Key Lock.

**NOTE: To switch to different USER, press “ENTER” + “MENU” buttons to “KEY LOCK” and then enter the different user’s password to UNLOCK.**

**HARDWARE CONNECTION AT SERVER SIDE**

**▶ Direct Connect with PC**

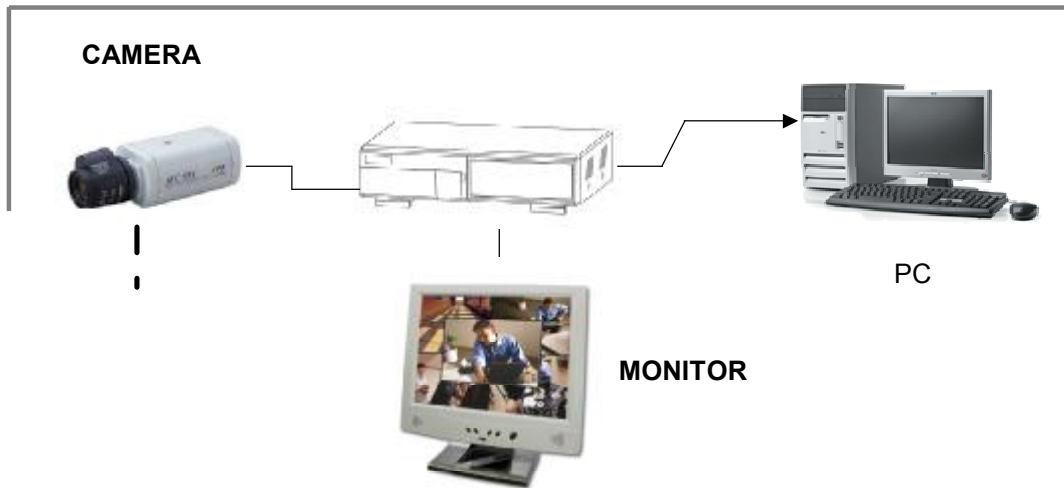

**▶ Remote Connect Via Internet**

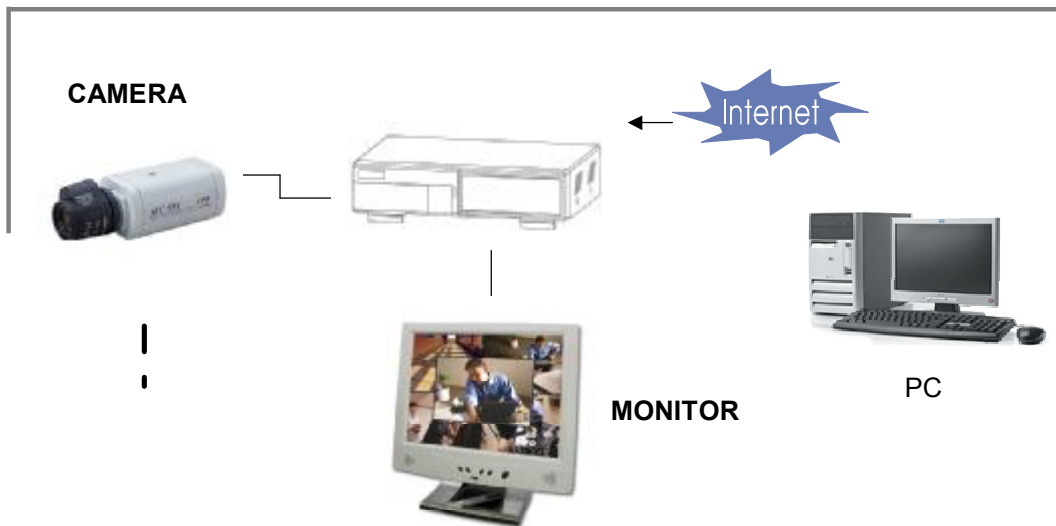

## SOFTWARE INSTALLATION

1. Put the attached CD into a CD-ROM and it will start to install the application program into PC.

2. Press “Next”.



3. Choose destination location and press “Next”.

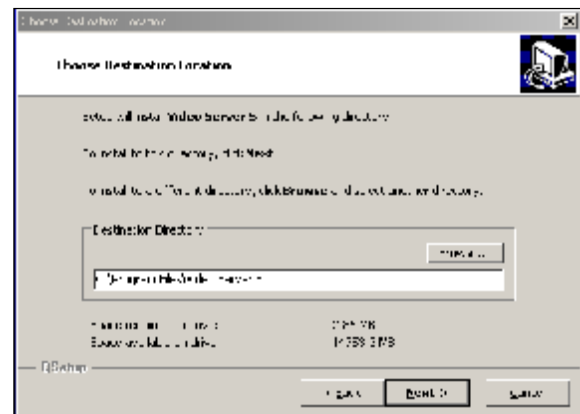

4. Set program shortcuts setting and press “Next”.

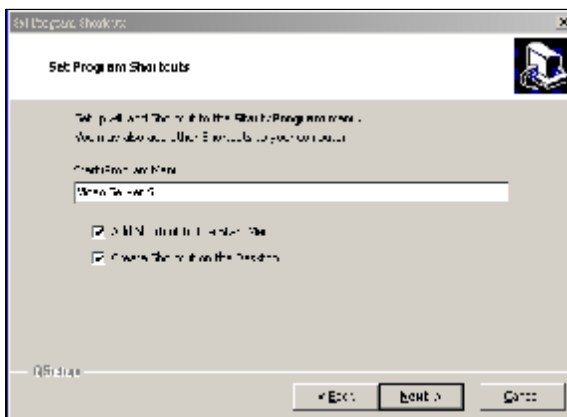

5. Press “Next” to begin to copy files

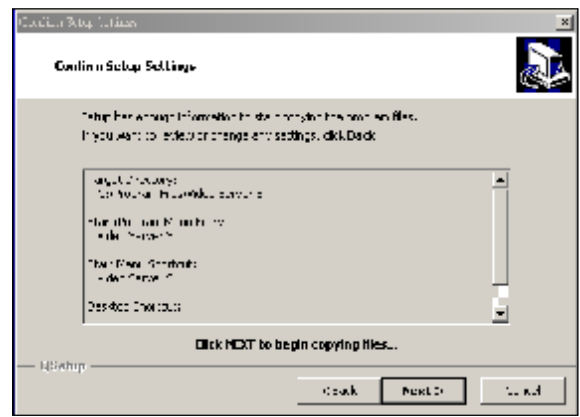

6. After the installation, there are 6 files and 1 folder in your assigned path (file folder) as below.



# LOCAL SETTING

## Local Area Network Setting

**Step 1** Please enter the net work menu and get the IP Address of this DVR.

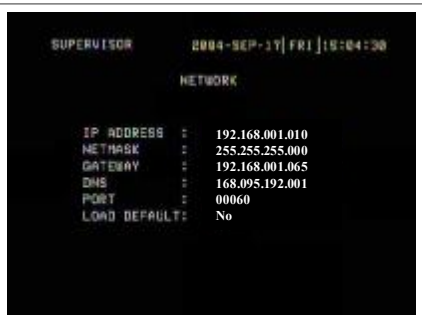

**Step 2** Network setting for PC. (The instruction is based on Win XP O/S. If your O/S is Win 2000 or Win 2003, the setup procedure is similar to that of Win XP O/S)



**Step 3** Click "Properties" for TCP/IP setup

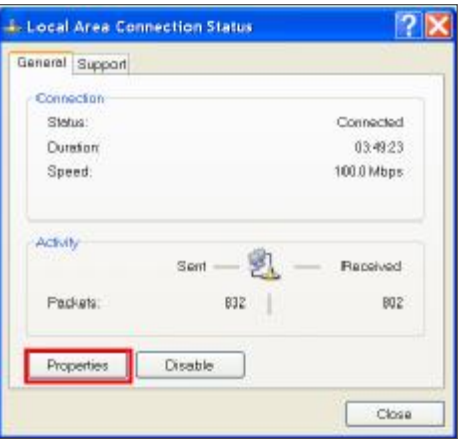

**STEP 4** Click on "INTERNET PROTOCOL (TCP/IP)" and then select "Properties" to setup

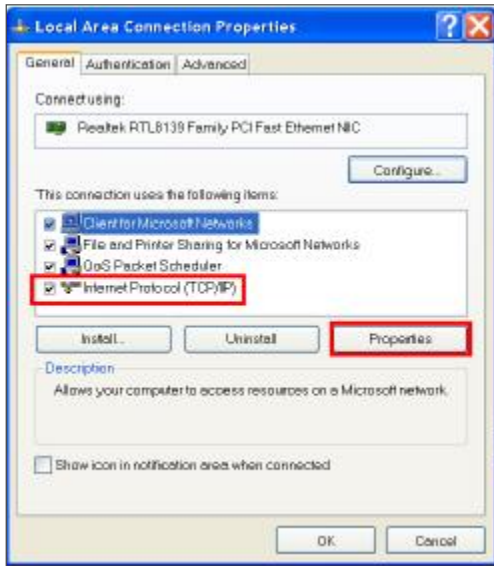

**STEP 5** Choose "Use the following IP address"

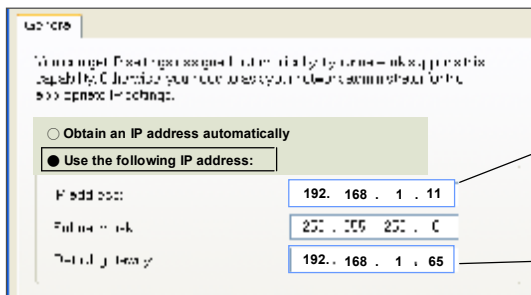

The last number of IP address between 1-255.  
But it cannot be the same as the DVR's IP.  
Gateway Number equal the gateway in the DVR.

**STEP 6** Connect DVR and Computer with cross over cable

**STEP 7** Click  twice and enter your User name, Password



DVR's IP

## STATIC IP SETTING

### Step1 : Static IP setting

In DVR MENU / NETWORK set IP ADDRESS, GATEWAY, NET MASK, DNS and WEB PORT which are provided from your local ISP ( internet service provider ).



For example

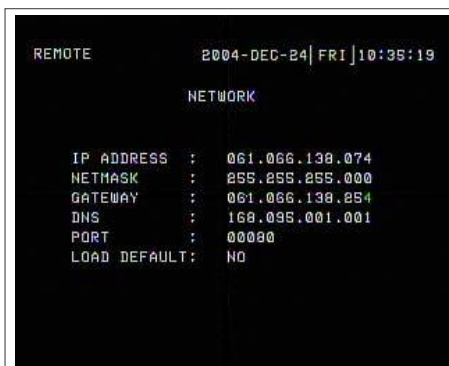

After all network settings are finished, please connect DVR and static IP.

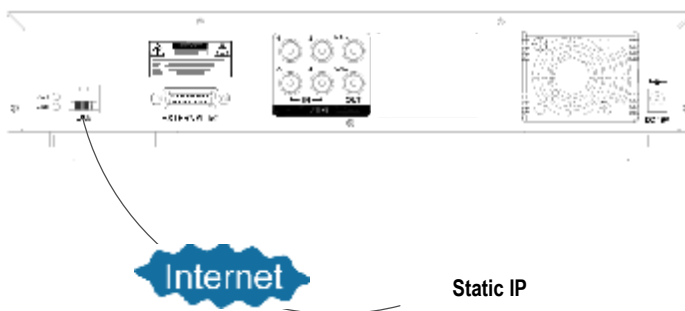

### Step2 : Connect PC and DVR via internet

Click  twice and enter your User name, Password (Note : If you never change the "Account" before, the User Name and Password are both "admin") and Server IP which you have set to DVR in step 2. Then click OK to connect.



A screenshot of a 'VIDEO WEB SERVER' login window. The window has a blue header with a computer icon and the text 'VIDEO WEB SERVER'. Below the header, there are four input fields: 'User Name' with 'admin' entered, 'Password' with '\*\*\*\*\*' entered, 'Server IP' with '61.66.138.74' entered, and 'Web Port' with '80' entered. To the right of the 'Web Port' field is an 'Address Book' button. At the bottom of the window, there are four buttons: 'OK', 'SEARCH', 'CANCEL', and a play button icon.

## DYNAMIC IP SETTING

### Step1 : Software installation

1.Put the attached CD into a CD-ROM and it will start to install the application program into PC.

2. Press “Next”.



3.Choose destination location and press “Next”.

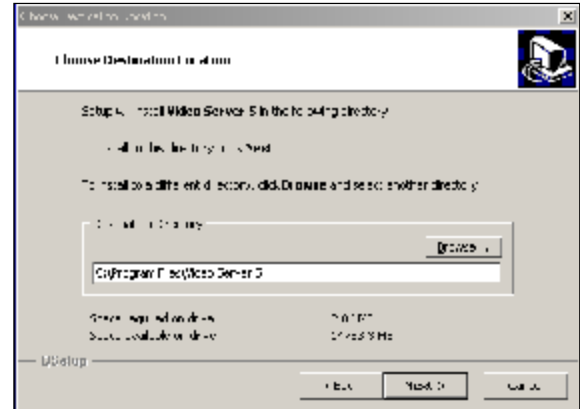

4.Set program shortcuts setting and press “Next”.

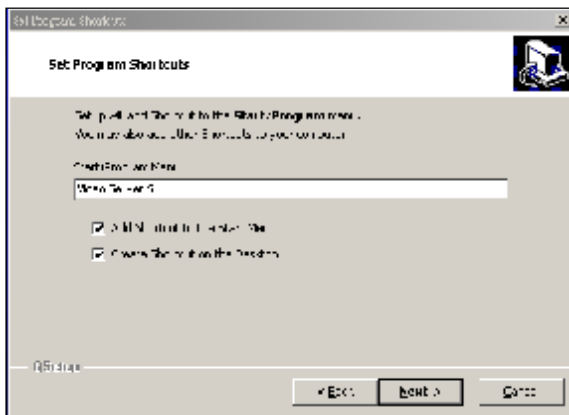

5.Press “Next” to begin copying files

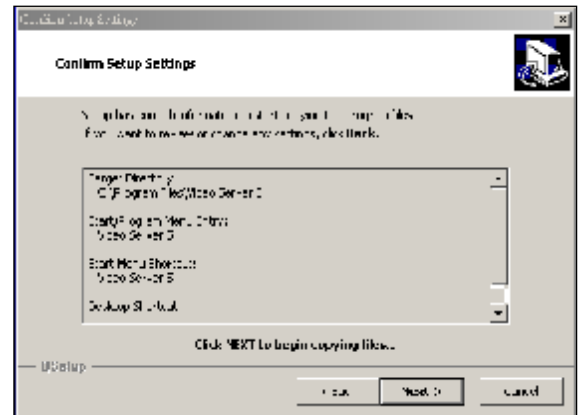

6.After the installation, there are 6 files and 1 folder in your assigned path (file folder) as below.



## Step2 : DDNS apply

1. Click on free site  
 “<http://www.dyndns.org>” ( please look at the example below, you can also apply DDNS in other DDNS web page) and “Account”.



2. Press “Create Account”.



3. Register the information and click on “Create Account”



4. After registering your account, you will receive an e-mail, which contains instructions to activate your account. If you do not follow these directions within 48 hours, you will need to re-register your account.

5. Login your account.



6. Click on “Account” and “Add Host”



- 7 Users can set up their own DDNS HOST. For example, the user’s applied Host name is “test.dyndns.org”. And then press “Add Host” to finish the setting. (NOTE : Some routers don’t support some DDNS HOST)



### **Step3 : Login router**

NOTE : The following settings are different from router to router. Please read the instruction of your router thoroughly.

#### 1.Connect PC and router (LAN end)

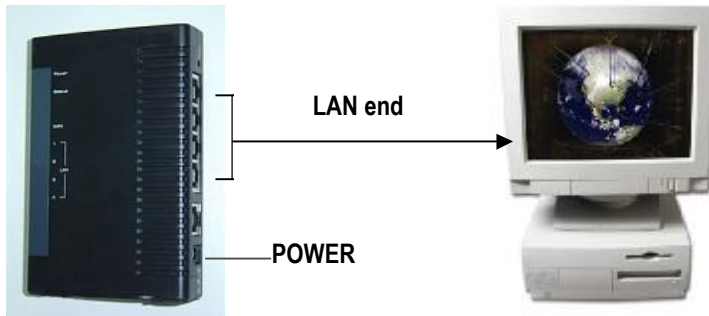

#### 2. Network setting for PC. (The instruction is based on Win XP O/S. If your O/S is Win 2000 or Win 2003, the setup procedure is similar to that of Win XP O/S)



#### 3.Click "Properties" for TCP/IP setup

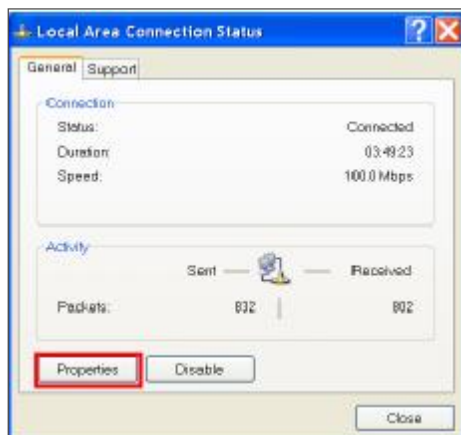

4. Click on "INTERNET PROTOCOL (TCP/IP)" and then select "Properties" to setup

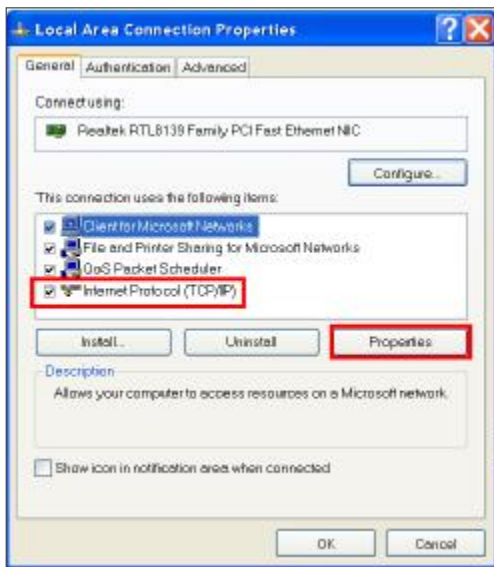

5. Choose "Obtain an IP address automatically"

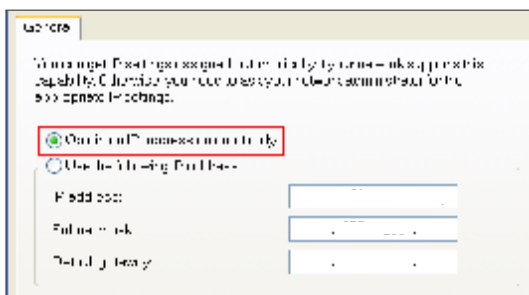

6. Enter "Command Prompt"

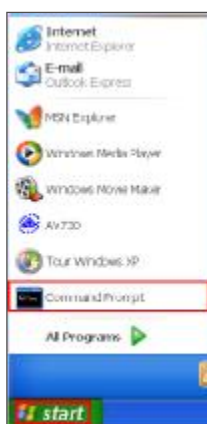

7. In the setting window, enter “ ipconfig” to write down router’s gateway(e.q. 192.168.1.1)

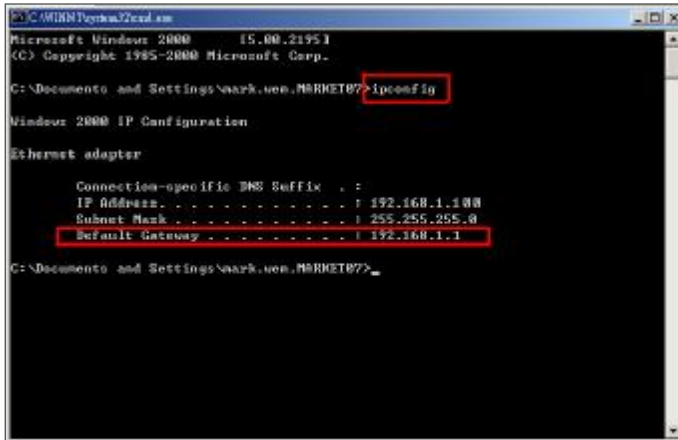

8. Close the window in the above step. Enter the IP address ( router’s gateway : 192.168.1.1 ) to log in to the router from internet explore. And then enter the login web page and key in the **router’s user name and password**.

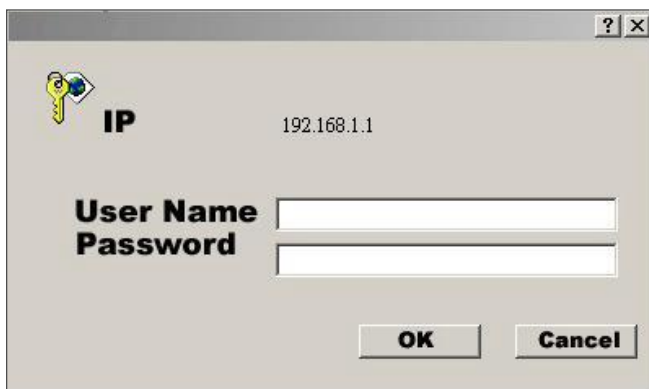

### **Step3 : Router setting**

**NOTE :** In the router setting, we have four steps as follows.

1. Dial setting
2. DHCP setting
3. Virtual server setting
4. DDNS setting

1. Press "INTERNET PORT" and choose your WAN type (e.g. PPPoE), and then enter your "User Name" and "Password" of dialing up to dynamic IP.

Press save after you finish the set up.

Broadband Router  
Broadband Router  
Broadband Router  
SETUP WIZARD

INTERNET PORT LOCAL PORT ADVANCED SETUP NETWORK STATUS OTHERS

Internet Port - DSL dynamic Mode

PPPoE (DSL dynamic mode)

Device Information  
Adapter Address: 00 - 00 - DC - 00 - 00 - 00 Modify  
Device/Computer Name: BRL-04AX  
Domain Name: \_\_\_\_\_

PPPoE Information  
Active Profile: 1 2 3  
User Name: test  
Password: \*\*\*\*\*  
Confirm Password: \*\*\*\*\*  
Service Name: test

2. Press "LOCAL PORT" and set "Start IP address" and "Number of IP address".

(For example, if the IP address of DVR is 192.168.1.10, then 10 is excluded from the setting range) Press save after you finish setting up.

Broadband Router  
Broadband Router  
Broadband Router  
SETUP WIZARD

INTERNET PORT LOCAL PORT ADVANCED SETUP NETWORK STATUS OTHERS

Local Port

Private Network  
IP Address: 192 168 1 1  
Subnet Mask: 255 255 255 0

DHCP Server  
 Do not distribute IP address to local computers  
 Distribute IP address to local computers  
Start IP address: 192 168 1 30  
Number of IP address: 20 (1-253)  
Static DHCP IP & MAC add.: Config.  
WINS Server: 0 0 0 0

3. In "ADVANCED SETUP / Virtual Server". Choose "By Port" and set "Port Number" to 80 for DVR. And set "Local Server IP Address" to 192.168.1.10.

Press add after you finish the set up.

Broadband Router  
Broadband Router  
Broadband Router  
SETUP WIZARD

INTERNET PORT LOCAL PORT ADVANCED SETUP NETWORK STATUS OTHERS

Virtual Server

Add Virtual Server  
Method:  By Name  By Port  
Application (Port): HTTP (80)  
Port Type:  TCP  UDP  
Single/Range:  Single  Range  
Port Number: 80 to \_\_\_\_\_  
Local Server IP Address: 192 168 1 10

4. In “ADVANCED SETUP / Dynamic DNS”. Key in the “DNS Account”, “User Name” and “Password” that you applied in step 3. Press save after you finish the set up.



### **Step4 : IP setting**

In DVR MENU / NETWORK set SERVER IP, GATEWAY, NET MASK, DNS and WEB PORT.



Please get the number of IP ADDRESS, NETMASK, GATEWAY, DNS, PORT, LOAD DEFAULT from your ISP company.

### **Step5 : Connect router**

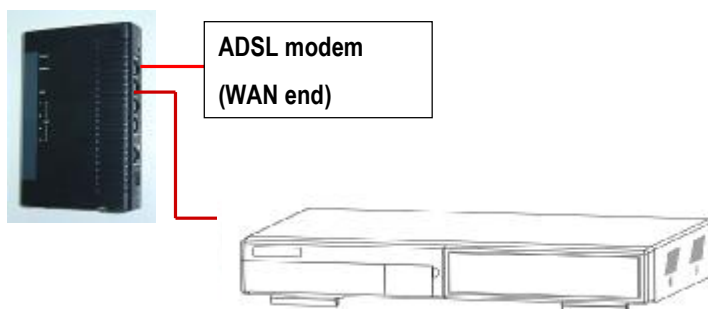

## **Step6 : Connect to DMR via internet**

1. Change PC network setting to the original setting and link PC to the internet.
2. Click  twice and enter your User name, Password and host (Note : The default User Name and Password are both “admin”). Then click OK to connect.

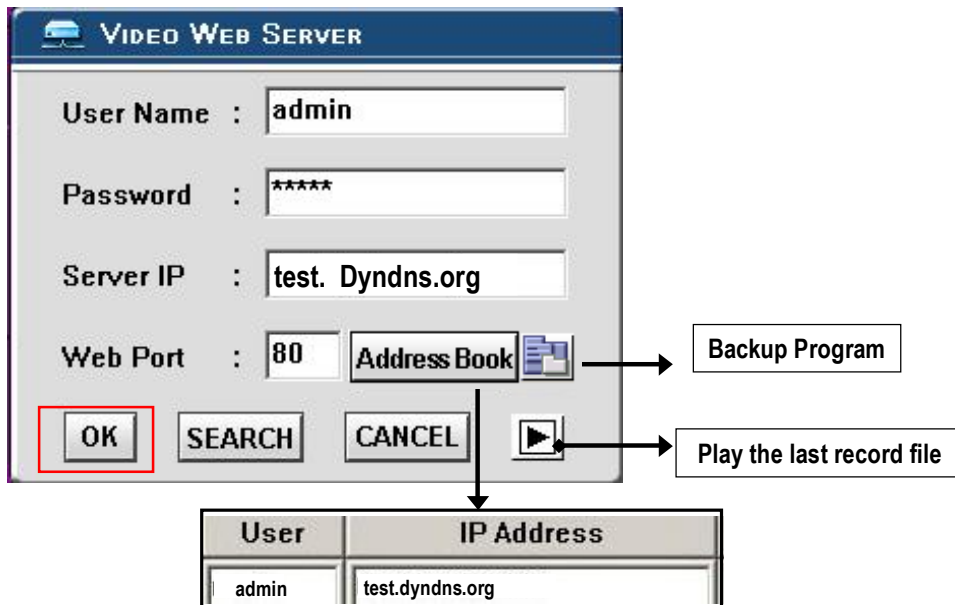

### **NOTE:**

You can get the software via attached CD.

#### **❖Address Book**

You can press “Address Book” button to add a new IP or choose any logged IP address to access the Video Server. This function is designed to store the list of IP addresses which you can control and manage.

#### **❖Backup Program**

You can press “” button and you can backup all related files of this application program to any storage device that you want (for example: any hard disk or USB Flash Drive).

#### **❖Play last record file**

You can press “” button and you can play the last record file.

## **Note of Dynamic IP setting**

- \*In step 2.7 : Some routers don't support some DDNS HOST.
- \*In step 3.1 : Please use router's LAN end to connect PC.
- \*In step 3.8 : Please use IE browser to enter router's gateway.
- \*In step 4.1 : Please make sure that you have pressed save after setting.
- \*In step 4.2 : Please make sure that you have pressed save after setting.
- \*In step 4.3 : Please make sure that you have pressed add after setting.
- \*In step 4.4 : Please make sure that you have pressed save after setting.
- \*In step 6 : Please use router's LAN end to connect to DMR. Use WAN end to connect to ADSL modem.
- \*In step 7 : The Server IP is the DDNS HOST which you set in step 4.4.

## SOFTWARE OPERATION AT CLIENT SIDE

Follow the steps for connection at your client site (remote site).

**Step 1** : Click  twice to enter Login setup (please refer to page 18“software installation”)

**Step 2** : Key in “User Name” and “ Password”. Click “OK” to establish the connection.

**Step 3** : If you could see the video screen as following, you have been connecting successfully to the server.



## INTRODUCTION OF BASIC OPERATION

### A. Video Web Server control panel



1. Image transmission rate per second
2. Data transmission rate
3. Connection/Disconnection
4. Resolution : D1 、 CIF
5. Image quality : High 、 Middle 、 Low
6. Image adjusting : Brightness/ Contrast/ Saturation
7. Snapshot : press this button, the image will be automatically saved in the PC.
8. Record : press this button, the recording file will be saved in the PC automatically.
9. System Config
10. Number of online users

## B. Digital device control panel

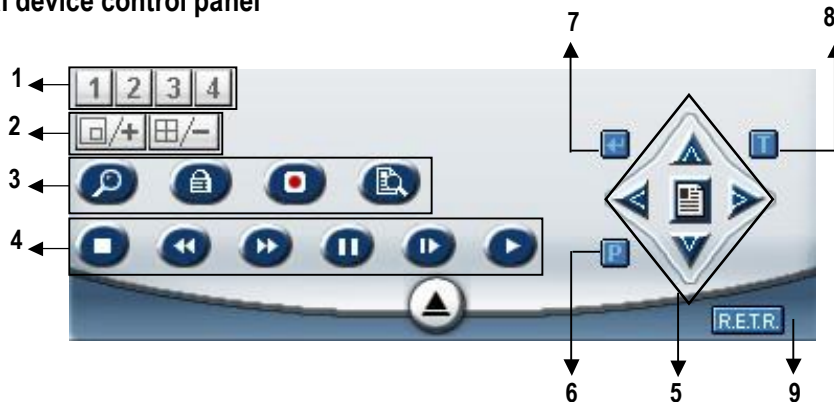

1. CH1-4
2. PIP/+, QUAD/- \*
3. Zoom, Lock, Record, Search
4. Stop, Rewind, Fast Forward , Pause,  
Slow, Play
5. Menu / up / down / left / right
6. PTZ
- 7.Enter
- 8.TURBO\*\*
- 9.R.E.T.R.

\* + / - :

Press “+” or “-” to change the default value.

\*\*TURBO:

Activate the turbo button when you would like to shift the selection more quickly by jumping 6 selections at a time.

**NOTE :**

After you press the record icon, there will be a recording file in the path that you have set. Each recording file can be save up to 6000 frames. The recording file will be assigned to the second file if it is more than 6000 frames. Besides, if the HDD space is less than 200MB, the program will stop recording.

## PLAYBACK OPERATION

Please find a recording file in the PC and click twice on it to playback.



1. On Screen Display
2. Snapshot
3. Stop
4. Pause
5. Slow (1/2, 1/4, 1/8, 1/16, 1/32)
6. PLAY
7. Fast
8. OSD show / hide
9. Config Setting
10. Open Last File
11. Open Next File
12. Duration time / Status
13. Playback controlling bar

## ADVANCED SETTING

Click "SYSTEM CONFIG" for advanced setting.



### NOTE :

#### Apply--

After changing all setting, press "apply" to refresh the data.

#### Reboot--

Press this button to restart setting.

## ACCOUNT



Set up the user's account( Max 10 accounts) , password and authority ( Max 5 accounts on line at the same time) .

### 1.User's level:

- SUPERVISOR**-control all the functions
- HIGH LEVEL**-control advanced functions
- NORMAL** -control basic functions only
- GUEST LEVEL** –watch the image only

**2.Life time** : During the period of time, users are allowed to control the Video Web Server.

## ALARM

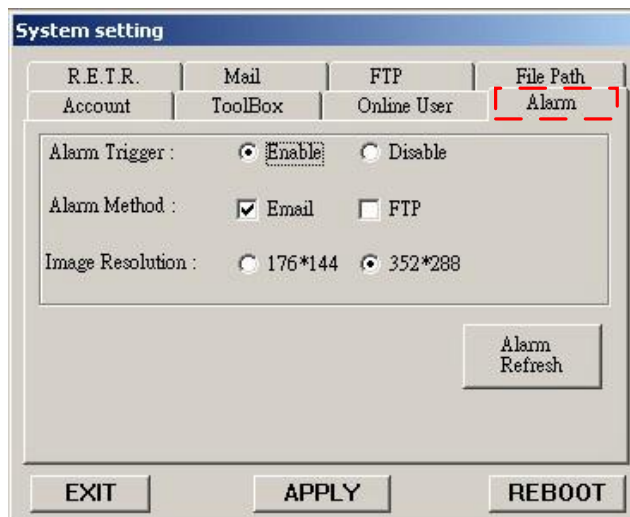

Set up the ALARM function. You can use it to operate "alarm trigger recording" function.

- 1.Alarm Trigger:** Enable or disable Alarm trigger function.
- 2.Alarm Method** : Two selections—E-mail or FTP.
- 3.Image Resolution** : Image storing resolution for Email or FTP function.  
(CIF is 176\*144; D1 is 352\*288)
- 4.Alarm refresh** : Clean the alarm message "🔴" which is showed on the screen.

## MAIL

System setting

|          |         |             |           |
|----------|---------|-------------|-----------|
| Account  | ToolBox | Online User | Alarm     |
| R.E.T.R. | Mail    | FTP         | File Path |

Server : mail.clix.pt

Mail from : test@factorone.pt

Verify Password  
Verify :  Yes  No

User :

Password :

Modify alarm email address

ADD DELETE EDIT

Mail Account

joaoluis.costa@factorone.pt

EXIT APPLY REBOOT

When the alarm is triggered, the video server program will capture the instant picture and e-mail the captured image to the assigned recipients.

1. Get all the data from the ISP company or by mailing to the server supplier.(SMTP server)
2. Set the mail list which you want to send to when the alarm is triggered.
3. No matter you set up the verify password or not, it depend on your mail server. If it is not necessary. Please choose verify as "No".

## FTP

System setting

|          |         |             |           |
|----------|---------|-------------|-----------|
| Account  | ToolBox | Online User | Alarm     |
| R.E.T.R. | Mail    | FTP         | File Path |

UserName :

Password :

Port : 21

Server :

Directory :

EXIT APPLY REBOOT

When the alarm is triggered, the video server program will capture the instant picture and upload the captured image to the assigned FTP site.

1. Get all the data from your FTP provider.
2. The default uploading port is No.21.
3. Set the uploading directory.

**Note:** Mail function and FTP function would work when the alarm trigger is enabled.

## File Path

System setting

|          |         |             |           |
|----------|---------|-------------|-----------|
| Account  | ToolBox | Online User | Alarm     |
| R.E.T.R. | Mail    | FTP         | File Path |

Record Path :  C:\Documents and Settings\test\desktop

Modify

Snapshot Path :  C:\Documents and Settings\test\desktop

Modify

Audio Path :  C:\Program Files\Video Server S\alarm.wav

Modify

EXIT APPLY REBOOT

You can modify the storing path for recording file and snapshot images.

## TOOLBOX

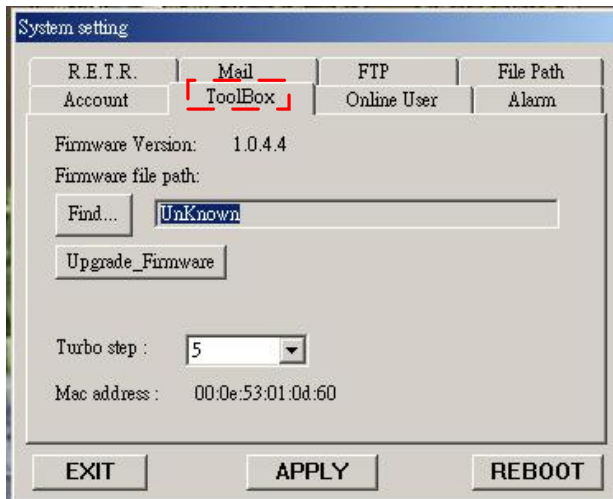

Upgrade the firmware and get the online users' information.

**NOTE :Do not reboot the DVR while it is upgrading the firmware.**

- 1.Firmware Version :** The current firmware version.
- 2. Find and upgrade Firmware:** Please get the firmware from your agent and save it in your PC or USB. Press "Find" button to get the latest firmware from PC and press "Upgrade\_Firmware" to upgrade it.
- 3.Turbo Step:** Set the shift step when you shift the zone which you see during the zoom in function.

## Online User

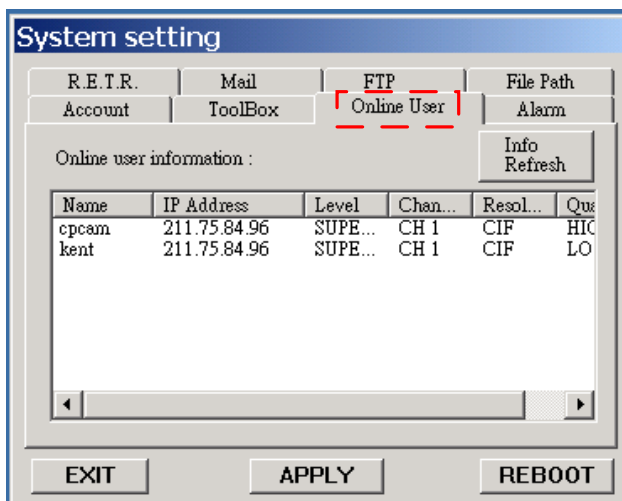

1.The information of online user.

2. Chat function. Users are on line at the same time and two of them can talk to each other. Click the name of the other user. A window as below will jump out. Click OK.

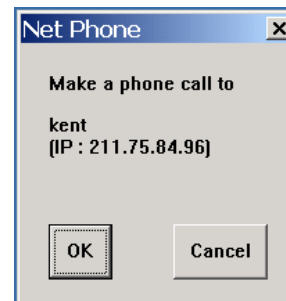

**NOTE:** Please turn (activate) all transmission TCP and UDP ports. Fire wall and similar software may disrupt normal transmission.

## RETR

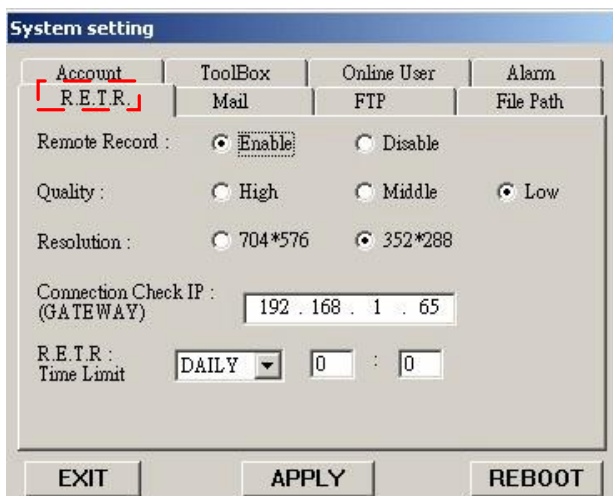

RETR setup.

- 1. Remote Record :** please click "Enable" to start it.
- 2. Quality :** High, Middle and Low.
- 3. Resolution :** 704\*576, 352\*288 ◦
- 4. Connection Check IP :** check the connection situation of network.
- 5. R.E.T.R. Time Limit :** end time setup.

## CONNECT VIDEO WEB SERVER VIA IE BROWSER

You can also connect Video Web Server via browser. This function is suitable in both WIN 2000 and WIN XP (WIN XP is preferable to WIN 2000)

**Step 1** : Enter IP address that you want to connect.(example)



**Step 2** : Enter your Username and Password to login Video Web Server.



**Step 3** : After you login, you will see as below. (example)

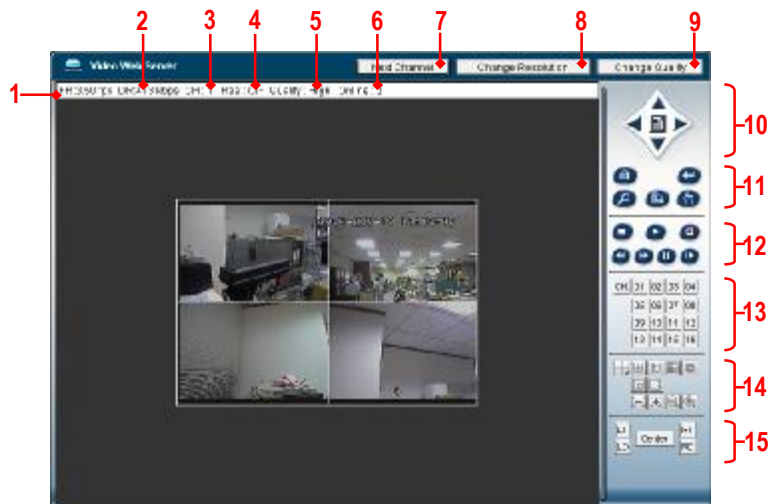

1.Image transmission rate per second

2.Data transmission rate

3.Video Channel

4. Resolution :D1 、 CIF

5.Image quality : High 、 Middle 、 Low

6.Number of online users

7.Channel switching button

8.Resolution switching button

9.Quality switching button

10.Menu, Left, Right, Up, Down, Exit

11.Lock, Enter, Zoom, Search, Select.

12.Stop, Play, Record, Rew, Fast, Pause, Slow,

13.Camera

14.4cut, PIP

15.Position of view

Note: If you control the DVR via IE Browser, the RETR function can not be worked.

## TROUBLESHOOTING

When malfunction occurs, it may not be serious and can be corrected easily. The table below describes some typical problems and their solutions. Please check them before calling your DVR dealer.

| PROBLEM  | SOLUTION   |
|--|--|
| No power   | <ul style="list-style-type: none"> <li>● Check power cord connections.</li> <li>● Confirm that there is power at the outlet.</li> </ul>  |
| Not working when pressing any button                                   | <ul style="list-style-type: none"> <li>● Check if it is under Key Lock mode.</li> <li>● Press "<b>MENU</b>" &amp; "<b>ENTER</b>" to exit Key Lock mode.</li> </ul>   |
| No recorded video  | <ul style="list-style-type: none"> <li>● Check if the HDD is installed properly.</li> </ul>  |
| Timer Record enable does not working                                   | <ul style="list-style-type: none"> <li>● Check if the Record Enable is set to YES</li> </ul>   |
| No live video  | <ul style="list-style-type: none"> <li>● Check camera video cable and connections.</li> <li>● Check monitor video cable and connections.</li> <li>● Confirm that the camera has power.</li> <li>● Check the setting of camera lens.</li> </ul> |
| NTSC & PAL System switch   | To switch the system, press " <b>FF</b> " to NTSC system and " <b>REW</b> " to PAL system. (Refer to Page 6 "GETTING STARTED".)  |
| Under overwriting and duplex modes, the playback motion is interrupted | please press "STOP" button and then the "PLAY" button to play again  |



## APPENDIX A– INSTALL THE HDD

Follow the steps carefully in order to ensure correct installation.

The compartment located on the front panel of the DVR is the removable Cartridge, in which you insert the HDD. The various parts of the Cartridge are labeled for your reference.

**\*\*\*Note: Users need to set the HDD on the Master mode for the system detecting.\*\*\***

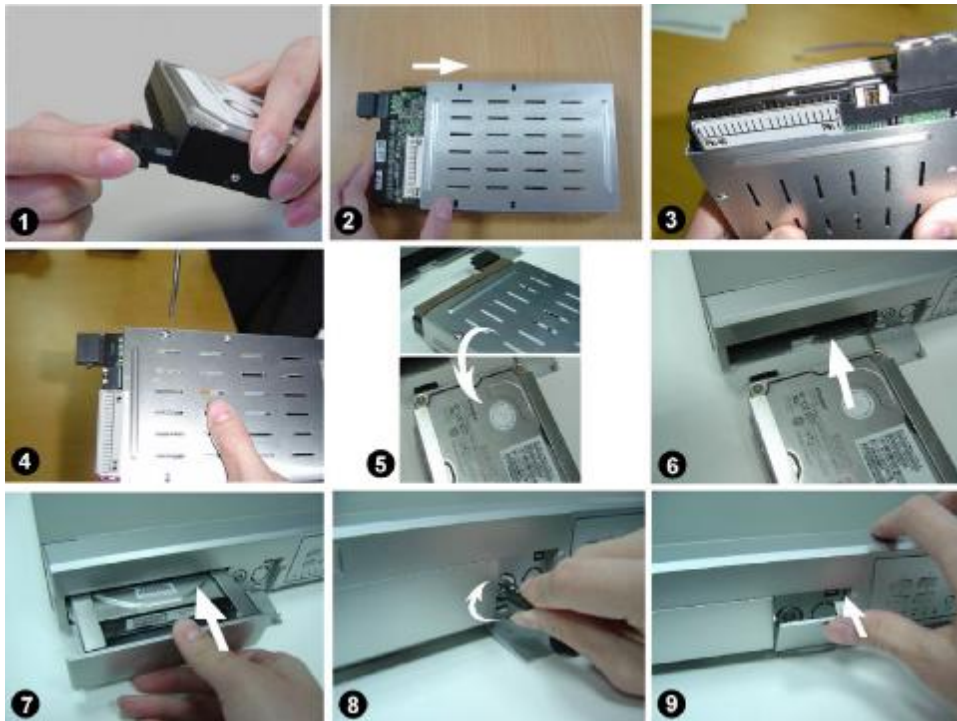

**Step 1** Connect the connector with the HDD (refer to Picture 1).

**Step 2** Put HDD into the HDD cartridge. Please notice the bottom side is power side as chart shows (refer to Picture 2).

**Step 3** Screw the HDD to the cartridge. Before you screw the HDD, please be aware that you must to level pin 1 of the HDD at pin 1 mark, because the screw hole is different from different HDD brands.

Then screw the HDD correctly (refer to Picture 3 and 4). **You must precisely align the hard disk to the pin connection to ensure correct installation.**

**Step 4** Reverse the HDD and put it into DVR (refer to Picture 5 and 6).

**Step 5** Connect the HDD with DVR (refer to Picture 7).

**Step 6** Lock the cabinet by turning the key clockwise (refer to Picture 8).

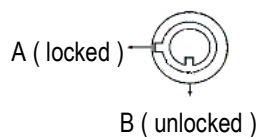

**Note :** If you do not lock the cabinet, the DVR system will not function properly.

**Step 7** Close the cap (refer to Picture 9).

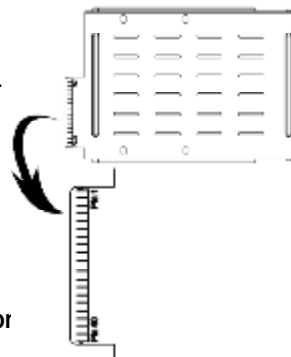



## APPENDIX B— REPLACE THE HDD



**Step 1** Open the cap



**Step 2** Unlock the cabinet by turning the key anti-clockwise

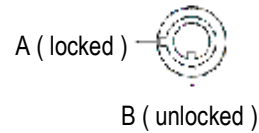

**Step 3** Pull out the cartridge



**Step 4** Loosen all screws on the Cartridge



**Step 5**

- Note:** 1. If you want to change a different HDD, you must remove the connectors from HDD ( refer to Page 44 ).  
 2. When HDD works for a period of time, the surface temperature will be high, please pay attention to it.  
 3. After turning the key to unlock position, please wait for several seconds until HDD operation stop completely.

### **HDD HOT SWAP FUNCTION**

Please follow the steps as following to ensure the reliability.

- 1)Unlock the cabinet by turning the key anti-clockwise.
- 2)Key in your password and press enter to disable the hard drive.
- 3)Pull out the HDD cartridge.
- 4)Replace the HDD in the tray.

**Note:** After turning the key to unlocked position, please wait for several seconds till HDD operation stops completely.



## APPENDIX C— RECORDING SPEED

The Recording Time is different based on Recording Speed, Recording Quality and Recording Mode.  
Please refer to following table. HDD capability is 250GB.

### NTSC SYSTEM

| IPS            |        | 30    | 15    | 5      |
|----------------|--------|-------|-------|--------|
| Multiplex Mode | Best   | 106hr | 212hr | 636hr  |
|                | High   | 132hr | 264hr | 792hr  |
|                | Normal | 213hr | 426hr | 1278hr |
|                | Basic  | 326hr | 652hr | 1956hr |
| HDD Type       | 250 GB |       |       |        |

### PAL SYSTEM

| IPS            |        | 25    | 12    | 4      |
|----------------|--------|-------|-------|--------|
| Multiplex Mode | Best   | 106hr | 212hr | 636hr  |
|                | High   | 132hr | 264hr | 792hr  |
|                | Normal | 213hr | 426hr | 1278hr |
|                | Basic  | 326hr | 652hr | 1956hr |
| HDD Type       | 250 GB |       |       |        |



## APPENDIX D— PIN CONFIGURATIONS

### 15 pin com port

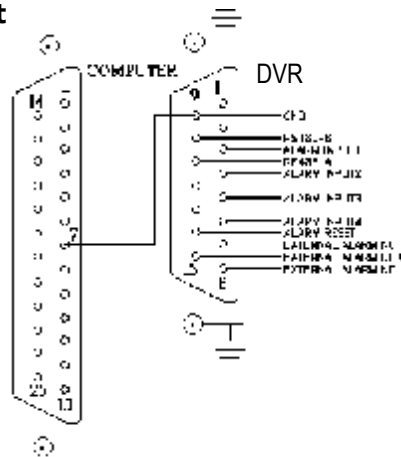

### 9 pin com port

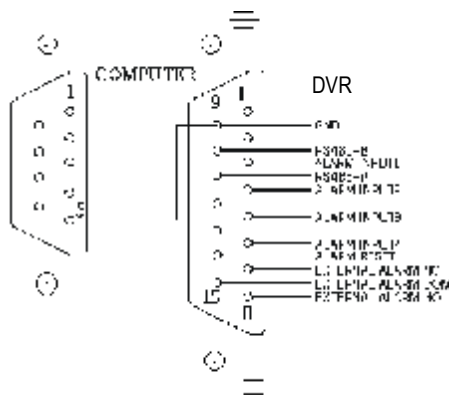

#### PIN 3, 4, 5, 6 ALARM INPUT

To connect wire from **ALARM INPUT (PIN 3, 4, 5, 6)** to **GND (PIN 9)** connector. When alarm has been triggered, signal becomes “Low”, and it will stop all alarm activities. Under normal operation, signal remains “High”.

#### PIN 7. EXTERNAL ALARM NC

Under normal operation COM connect with NC and disconnect from NO. But when alarm is triggered, COM disconnect with NC, and connect with NO.

#### PIN 8. EXTERNAL ALARM NO

Under normal operation, COM will disconnect from NO. But when Alarm is triggered, COM will connect with NO.

#### PIN 9. GND

GROUND

#### PIN 10. RS485-B

DVR can be controlled remotely by an external device or control system, such as a control keyboard, using RS-485 serial communications signals.

#### PIN 11. RS485-A

DVR can be controlled remotely by an external device or control system, using RS-485 serial communications signals.

#### PIN 14. ALARM RESET (INPUT)

To connect wire from **ALARM RESET (PIN 14)** to **GND (PIN 9)** connector, it can disable ALARM. An external signal to **ALARM RESET (PIN 14)** can be used to reset both **ALARM OUTPUT** signal and DVR’s internal buzzer. When alarm has been triggered, signal becomes “Low”, and it will stop all alarm activities. Under normal operation, signal remains “High”.

#### PIN 15. EXTERNAL ALARM COM

Under normal operation COM connect with NC and disconnect from NO. But when alarm is triggered, COM disconnect from NC, and connect with NO.